



Product Catalogue

2023 | 2024

Intelligent Simplicity

Explore

Intelligent Simplicity

Neoss offers intelligent solutions that are intuitively easy to use. Our products allow dental professionals to provide reliable and cost-effective treatments to their patients with predictable long-term results. With ingenuity and ambition, we strive to set new standards, leading the market with integrity. In developing smart treatment solutions and working closely with our customers, Neoss makes the complex less complicated. We call that Intelligent Simplicity.



Implants	4	Neoss ProActive® Edge Implants
	6	Neoss ProActive® Tapered Implants Neoss ProActive® Wide Implants Neoss ProActive® Sinus Implants
	7	Neoss ProActive® Straight Implants
	8	Neoss ProActive® Straight NP Ø3.25 Implants Cover Screw
Biomaterials	9	Resorbable Membranes Collagen Membranes Non-Resorbable Membranes Ti-reinforced PTFE Membranes NeoGen® Cape
	10	Non-reinforced PTFE Membranes Fixation Kit Sutures Other
Digital	12	Resonance Frequency Device (RFA) NeoTell™ NEW Intraoral Scanners NeoScan™ 1000
	13	Digital Impression Esthetic Healing Abutments with ScanPeg ScanPeg Scan Bodies Analogs
	14	Digital Prosthetics NeoBase® Abutments SSC (Straight Screw Channel) NeoBase® Abutments ASC (Angulated Screw Channel) Neoss TiBase Abutments (compatible with Dentsply Sirona®)
	15	Ti NeoLink® Custom Solutions Neoss NT Blanks, SSC Neoss CM Blanks, SSC
	16	ARC Solutions
	17	Crown Zirconia on NeoBase Crown Zirconia on Custom Abutment Bridge Zirconia on NeoBases OneToOne Ti Bar & Zirconia Bridge Other products milled or additive printed by ARC
Prosthetics	18	Neoss4+ treatment solution Multi-Unit Abutments NEW
	19	Access Abutments Multi-Unit/Access Screws
	20	Healing Abutments Esthetic Healing Abutments with ScanPeg Healing Abutments Provisional Abutments Esthetic Tissue Formers
	21	Provisional Titanium Abutments Final Abutments Prepable Titanium Abutments Prepable Titanium Abutments, Alternative Emergence Profiles
	22	Zirconia Abutments Final Restorations – Casting Gold NeoLink® (Direct Casting) CoCr Abutments (Indirect Casting) Burnout Abutments (Direct Casting)
	23	Overdenture Abutments Equator Abutments Bar Abutment
	24	Impressions & Replicas Impressions Copings Replicas Screws
Instruments & More	25	Drills
	27	Kits Surgical & Prosthetic Trays Surgical & Prosthetic Kits with instruments and drills
	28	Guide Neoss® Guide Kit – SPARE PARTS Demo Kit
	29	Instruments
Support	30	Prosthetic Solution Standard and Narrow Platform, overview Torque and Speed recommendation, overview
	31	Symbols, names and abbreviations You can now buy your products online! Disclaimer of Liability

Neoss ProActive® implants – *Proven predictability* in implant treatment since 2002

All implants produced of highest quality, Commercially Pure Titanium Grade 4.

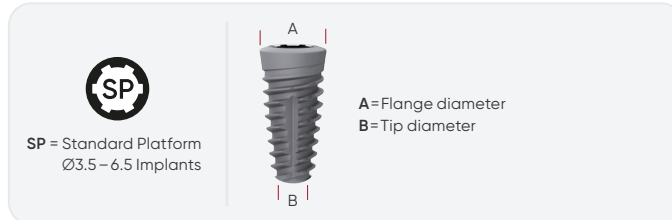
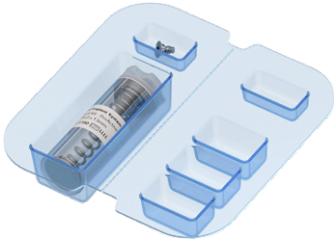

Neoss Implant

The Implant includes Implant and Cover Screw.



Neoss ProActive® Edge Implants

Art. No.	Description	A	B
21417	Implant – Neoss ProActive® Edge Ø3.5×9 mm		
21418	Implant – Neoss ProActive® Edge Ø3.5×11 mm		
21419	Implant – Neoss ProActive® Edge Ø3.5×13 mm	4.0 mm	1.6 mm
21420	Implant – Neoss ProActive® Edge Ø3.5×15 mm		
21421	Implant – Neoss ProActive® Edge Ø3.5×17 mm		
21423	Implant – Neoss ProActive® Edge Ø4.0×9 mm		
21424	Implant – Neoss ProActive® Edge Ø4.0×11 mm		
21425	Implant – Neoss ProActive® Edge Ø4.0×13 mm	4.3 mm	1.9 mm
21426	Implant – Neoss ProActive® Edge Ø4.0×15 mm		
21427	Implant – Neoss ProActive® Edge Ø4.0×17 mm		
21429	Implant – Neoss ProActive® Edge Ø4.5×9 mm		
21430	Implant – Neoss ProActive® Edge Ø4.5×11 mm		
21431	Implant – Neoss ProActive® Edge Ø4.5×13 mm	4.9 mm	2.2 mm
21432	Implant – Neoss ProActive® Edge Ø4.5×15 mm		
21433	Implant – Neoss ProActive® Edge Ø4.5×17 mm		
21435	Implant – Neoss ProActive® Edge Ø5.0×9 mm		
21436	Implant – Neoss ProActive® Edge Ø5.0×11 mm		
21437	Implant – Neoss ProActive® Edge Ø5.0×13 mm	5.4 mm	2.4 mm
21438	Implant – Neoss ProActive® Edge Ø5.0×15 mm		
21439	Implant – Neoss ProActive® Edge Ø5.0×17 mm		

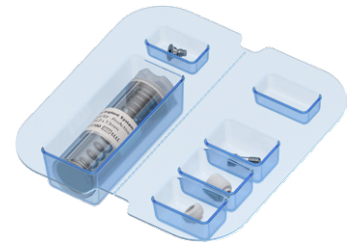
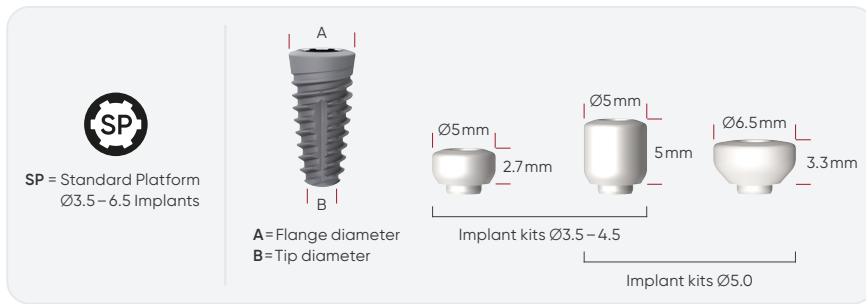

Neoss Implant Kit

The Implant Kit includes Implant, Cover Screw, Healing Abutments in PEEK in two different sizes and Healing Abutment Screw.

Neoss ProActive® Edge Implants

Art. No.	Description	A	B
21301	Implant Kit – Neoss ProActive® Edge Ø3.5×9mm		
21302	Implant Kit – Neoss ProActive® Edge Ø3.5×11mm	4.0mm	1.6mm
21303	Implant Kit – Neoss ProActive® Edge Ø3.5×13mm		
21304	Implant Kit – Neoss ProActive® Edge Ø3.5×15mm		
21305	Implant Kit – Neoss ProActive® Edge Ø4.0×9mm		
21306	Implant Kit – Neoss ProActive® Edge Ø4.0×11mm	4.3mm	1.9mm
21307	Implant Kit – Neoss ProActive® Edge Ø4.0×13mm		
21308	Implant Kit – Neoss ProActive® Edge Ø4.0×15mm		
21309	Implant Kit – Neoss ProActive® Edge Ø4.5×9mm		
21310	Implant Kit – Neoss ProActive® Edge Ø4.5×11mm	4.9mm	2.2mm
21311	Implant Kit – Neoss ProActive® Edge Ø4.5×13mm		
21312	Implant Kit – Neoss ProActive® Edge Ø4.5×15mm		
21313	Implant Kit – Neoss ProActive® Edge Ø5.0×9mm		
21314	Implant Kit – Neoss ProActive® Edge Ø5.0×11mm	5.4mm	2.4mm
21315	Implant Kit – Neoss ProActive® Edge Ø5.0×13mm		
21316	Implant Kit – Neoss ProActive® Edge Ø5.0×15mm		



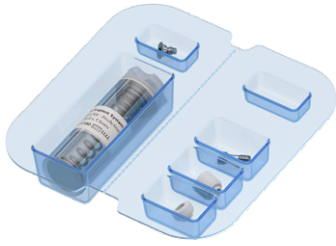

Neoss Implant Kit

The Implant Kit includes Implant, Cover Screw, Healing Abutments (Ø5.0 – 5.5 implant kits include a wider version) in PEEK in two different sizes and Healing Abutment Screw.

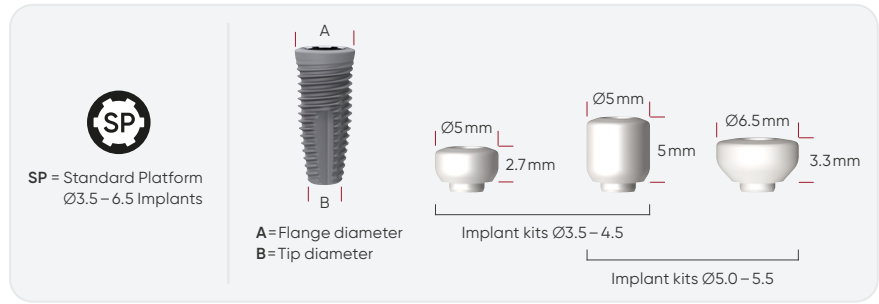

Neoss ProActive® Tapered Implants

Art. No.	Description	A	B
21221	Implant Kit – Neoss ProActive® Tapered Ø3.5×9mm		
21222	Implant Kit – Neoss ProActive® Tapered Ø3.5×11mm	4.0mm	2.1mm
21223	Implant Kit – Neoss ProActive® Tapered Ø3.5×13mm		
21224	Implant Kit – Neoss ProActive® Tapered Ø3.5×15mm		
21227	Implant Kit – Neoss ProActive® Tapered Ø4.0×9mm		
21228	Implant Kit – Neoss ProActive® Tapered Ø4.0×11mm	4.3mm	2.3mm
21229	Implant Kit – Neoss ProActive® Tapered Ø4.0×13mm		
21230	Implant Kit – Neoss ProActive® Tapered Ø4.0×15mm		
21233	Implant Kit – Neoss ProActive® Tapered Ø4.5×9mm		
21234	Implant Kit – Neoss ProActive® Tapered Ø4.5×11mm	4.9mm	2.8mm
21235	Implant Kit – Neoss ProActive® Tapered Ø4.5×13mm		
21236	Implant Kit – Neoss ProActive® Tapered Ø4.5×15mm		
21239	Implant Kit – Neoss ProActive® Tapered Ø5.0×9mm		
21240	Implant Kit – Neoss ProActive® Tapered Ø5.0×11mm	5.4mm	3.3mm
21241	Implant Kit – Neoss ProActive® Tapered Ø5.0×13mm		
21242	Implant Kit – Neoss ProActive® Tapered Ø5.0×15mm		
21245	Implant Kit – Neoss ProActive® Tapered Ø5.5×9mm		
21246	Implant Kit – Neoss ProActive® Tapered Ø5.5×11mm	5.9mm	3.8mm
21247	Implant Kit – Neoss ProActive® Tapered Ø5.5×13mm		

Neoss ProActive® Wide Implants

Art. No.	Description	A	B
21252	Implant Kit – Neoss ProActive® Ø6.0×7mm		4.5mm
21250	Implant Kit – Neoss ProActive® Ø6.0×9mm	6.0mm	4.3mm
21251	Implant Kit – Neoss ProActive® Ø6.0×11mm		4.3mm

Neoss ProActive® Sinus Implants

Art. No.	Description	A
21211	Implant Kit – Neoss ProActive® Ø6.5×7mm	
21212	Implant Kit – Neoss ProActive® Ø6.5×9mm	6.7mm
21213	Implant Kit – Neoss ProActive® Ø6.5×11mm	



SP = Standard Platform
Ø3.5-6.5 Implants

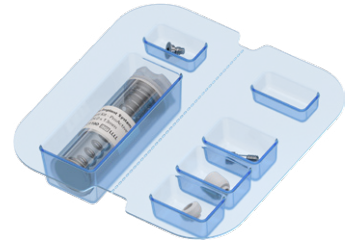
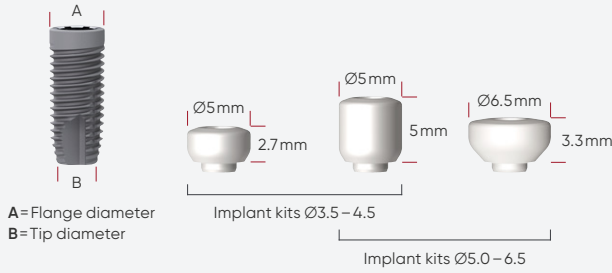

Neoss Implant Kit

The Implant Kit includes Implant, Cover Screw, Healing Abutments (Ø5.0-6.5 implant kits include a wider version) in PEEK in two different sizes and Healing Abutment Screw.

Neoss ProActive® Straight Implants

Art. No.	Description	A	B
21181	Implant Kit – Neoss ProActive® Straight Ø3.5×7mm		
21182	Implant Kit – Neoss ProActive® Straight Ø3.5×9mm		
21183	Implant Kit – Neoss ProActive® Straight Ø3.5×11mm	4.0mm	2.4mm
21184	Implant Kit – Neoss ProActive® Straight Ø3.5×13mm		
21185	Implant Kit – Neoss ProActive® Straight Ø3.5×15mm		
21186	Implant Kit – Neoss ProActive® Straight Ø3.5×17mm		
21187	Implant Kit – Neoss ProActive® Straight Ø4.0×7mm		
21188	Implant Kit – Neoss ProActive® Straight Ø4.0×9mm		
21189	Implant Kit – Neoss ProActive® Straight Ø4.0×11mm	4.0mm	2.8mm
21190	Implant Kit – Neoss ProActive® Straight Ø4.0×13mm		
21191	Implant Kit – Neoss ProActive® Straight Ø4.0×15mm		
21192	Implant Kit – Neoss ProActive® Straight Ø4.0×17mm		
21193	Implant Kit – Neoss ProActive® Straight Ø4.5×7mm		
21194	Implant Kit – Neoss ProActive® Straight Ø4.5×9mm		
21195	Implant Kit – Neoss ProActive® Straight Ø4.5×11mm	4.5mm	3.2mm
21196	Implant Kit – Neoss ProActive® Straight Ø4.5×13mm		
21197	Implant Kit – Neoss ProActive® Straight Ø4.5×15mm		
21198	Implant Kit – Neoss ProActive® Straight Ø4.5×17mm		
21199	Implant Kit – Neoss ProActive® Straight Ø5.0×7mm		
21200	Implant Kit – Neoss ProActive® Straight Ø5.0×9mm		
21201	Implant Kit – Neoss ProActive® Straight Ø5.0×11mm	5.0mm	3.7mm
21202	Implant Kit – Neoss ProActive® Straight Ø5.0×13mm		
21203	Implant Kit – Neoss ProActive® Straight Ø5.0×15mm		
21205	Implant Kit – Neoss ProActive® Straight Ø5.5×7mm		
21206	Implant Kit – Neoss ProActive® Straight Ø5.5×9mm		
21207	Implant Kit – Neoss ProActive® Straight Ø5.5×11mm	5.5mm	4.2mm
21208	Implant Kit – Neoss ProActive® Straight Ø5.5×13mm		



ProActive Straight Ø3.5



ProActive Straight Ø4.0



ProActive Straight Ø4.5



ProActive Straight Ø5.0



ProActive Straight Ø5.5

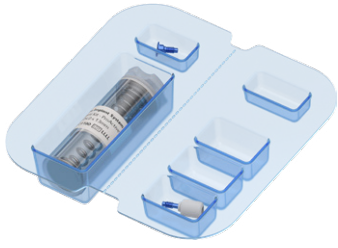

Neoss Implant Kit

The Neoss ProActive® NP Ø3.25 implant kit includes Implant, Cover Screw, Healing Abutment and Healing Abutment Screw.

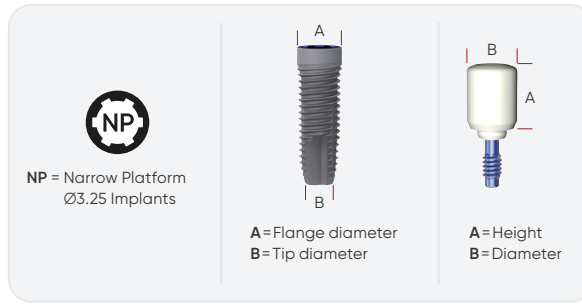

Neoss ProActive® Straight NP Ø3.25 Implants

Art. No.	Description	A	B
21176	Implant Kit – Neoss ProActive® Straight, NP Ø3.25×9 mm		
21177	Implant Kit – Neoss ProActive® Straight, NP Ø3.25×11 mm	3.5mm	2.2mm
21178	Implant Kit – Neoss ProActive® Straight, NP Ø3.25×13 mm		
21179	Implant Kit – Neoss ProActive® Straight, NP Ø3.25×15 mm		



Cover Screw

Art. No. Description

31408	Cover Screw SP
31409	Cover Screw NP

Solutions for your guided bone *regeneration* procedures

Resorbable Membranes

Collagen Membranes

Art. No.	Description	A	B
64050	NeoGen® Collagen Membrane Flex S	20mm	15mm
64051	NeoGen® Collagen Membrane Flex M	30mm	20mm
64052	NeoGen® Collagen Membrane Flex L <i>NeoGen® Collagen Flex resorbs in 3–4 months</i>	40mm	30mm



Collagene Flex

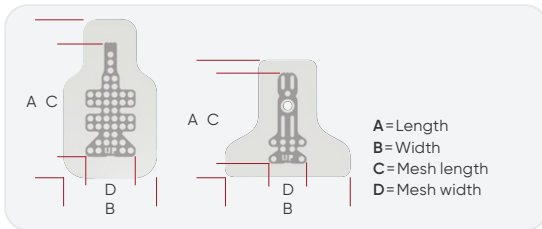

Non-Resorbable Membranes

Ti-reinforced PTFE Membranes

Art. No.	Description	A	B	C	D
64010	NeoGen® PTFE Membrane, Ti-Reinforced – S I <i>(Small Interproximal)</i>	29mm	14mm	19mm	4mm
64011	NeoGen® PTFE Membrane, Ti-Reinforced – M I <i>(Medium Interproximal)</i>	30mm	19mm	19mm	9mm
64012	NeoGen® PTFE Membrane, Ti-Reinforced – L I <i>(Large Interproximal)</i>	36mm	21mm	26mm	11mm
64013	NeoGen® PTFE Membrane, Ti-Reinforced – M <i>(Medium)</i>	32mm	22mm	23mm	12mm
64014	NeoGen® PTFE Membrane, Ti-Reinforced – L <i>(Large)</i>	34mm	25mm	24mm	15mm
64015	NeoGen® PTFE Membrane, Ti-Reinforced – XL <i>(Extra Large)</i>	46mm	32mm	24mm	15mm

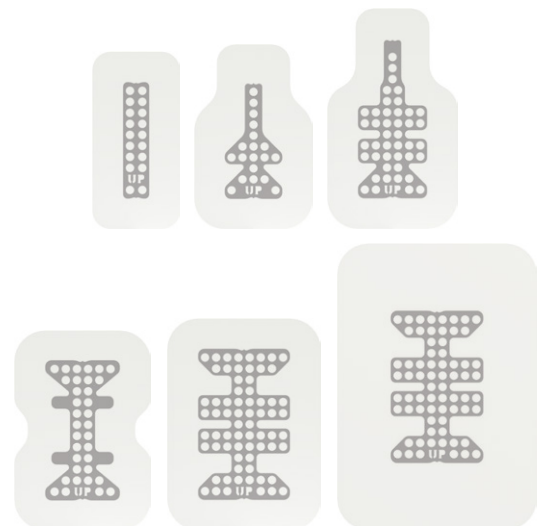

Ti-Reinforced Membranes

NeoGen® Cape

All NeoGen® Cape Spacer include a NeoGen® Cape Screw

Art. No.	Description	A	B	C	D
64040	NeoGen® Cape PTFE Membrane – M	28mm	30mm	16mm	9mm
64041	NeoGen® Cape PTFE Membrane – L	28mm	30mm	22mm	9mm
64080	NeoGen® Cape Spacer 0.7 mm, Neoss SP				
64081	NeoGen® Cape Spacer 1.5 mm, Neoss SP				
64082	NeoGen® Cape Spacer 0.7 mm, Neoss NP				
64083	NeoGen® Cape Spacer 1.5 mm, Neoss NP				



NeoGen® Cape



NeoGen® Cape Spacer



NeoGen® Cape Screw



Non-Reinforced Membranes

Non-reinforced PTFE Membranes

Art. No.	Description	A	B
64019	NeoGen® PTFE Membrane, Non-Reinforced	18mm	12mm
64020	NeoGen® PTFE Membrane, Non-Reinforced	29mm	14mm
64021	NeoGen® PTFE Membrane, Non-Reinforced	34mm	25mm



Tack Positioning Instrument



Tack Mallet



Tack and Screw Cassette



Membrane Tack



Membrane Screw

Fixation Kit

Art. No.	Description
64031	Tack Positioning Instrument
64033	Tack Mallet
64034	Tack and Screw Cassette
64036	Membrane Tack 3 mm – 10 pcs
64037	Membrane Screw 3 mm – 10 pcs

Sutures

Other

Art. No.	Description
32.Z4401.00	Neoss PTFE Suture 60 cm 4/0 – Reverse Cutting 16 mm 3/8 (12 pcs)
32.Z4408.00	Neoss PTFE Suture 60 cm 6/0 – Reverse Cutting 12 mm 3/8 (12 pcs)



PTFE Suture



The *measurement of implant stability* begins with NeoTell™

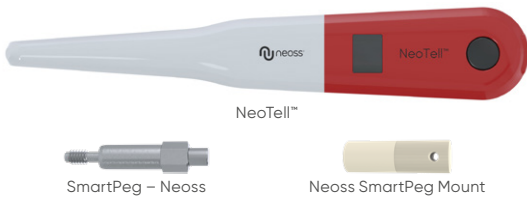

Resonance Frequency Device (RFA)

NeoTell™ **NEW**

Art. No. Description

91060	NeoTell™ Instrument <i>Includes NeoTell™ Instrument, SmartPeg Mount, TestPeg and USB cable, type A-C</i>
91070	SmartPeg Type 18 – Neoss SP
91071	SmartPeg Type 38 – Neoss NP
91072	SmartPeg Type 52 – Neoss Access Abutment
91075	Neoss SmartPeg Mount

SmartPegs for other brands are available, contact your local representative for details

New opportunities for your *EasyDigital* workflow



NeoScan™ 1000

Intraoral Scanners

NeoScan™ 1000

Art. No. Description

91000	NeoScan™ 1000 Intraoral Scanner <i>Includes Handpiece, 4 tips (2×S, 2×L), Holder Set, Manuals, Suitcase. Extended warranties are available for purchase</i>
91012	NeoScan™ 1000 – Tip L TP102N (2 pcs)
91013	NeoScan™ 1000 – Tip S TP103N (2 pcs)
91022	Trolley for Intraoral Scanner
91024	NeoScan™ 1000 – Warranty extension – 1 year
91026	NeoScan™ 1000 – Warranty extension – 2 years
91027	NeoScan™ 1000 – Warranty extension – 3 years

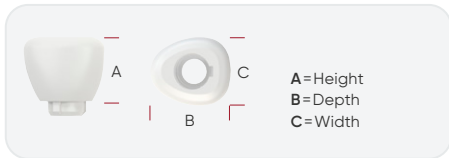

Digital Impression

Esthetic Healing Abutments with ScanPeg

All Esthetic Healing Abutments include Titanium Screw and a ScanPeg

Art. No.	Description	A	B	C
31360	Esthetic Healing Abutment with ScanPeg – Wide Incisor	5 mm	5.7 mm	6.1 mm
31361	Esthetic Healing Abutment with ScanPeg – Narrow Incisor		5.2 mm	5 mm
31362	Esthetic Healing Abutment with ScanPeg – Canine		6.3 mm	5.4 mm
31363	Esthetic Healing Abutment with ScanPeg – Pre-molar		6.8 mm	5.8 mm
31364	Esthetic Healing Abutment with ScanPeg – Molar		7.8 mm	7.3 mm



ScanPeg

Art. No. Description

Esthetic Healing Abutments with ScanPeg can also be utilised for digital impressions

31365	ScanPeg – 5 pcs Used only with Esthetic Healing Abutments
-------	--



Scan Bodies

Art. No. Description

90181	Scan Body Neoss® SP (IO 1A-A)
90182	Scan Body Neoss® NP (IO 1A-B)
90183	Scan Body Neoss® Access (IO 1B-A)
31450	Multi-Unit Scan Body



Analogs

Art. No. Description

90190	Analog for Printed Model Neoss® SP
90191	Analog for Printed Model Neoss® NP
90192	Analog for Printed Model Neoss® Access
91074	Analog for Printed Model Neoss® Multi-Unit
PMA-AIT-1	Elos Accurate® Analog Pliers
PMA-AIP-2	Elos Accurate® Analog Insertion Pin (2 pcs)
PMA-AIS-5	Elos Accurate® Analog Insertion Screw (5 pcs)

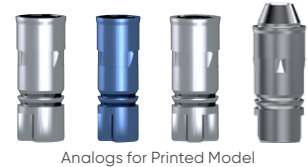

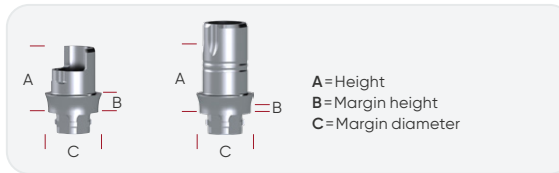

Digital Prosthetics

NeoBase® Abutments SSC (Straight Screw Channel)*

also referred to as TiBase

All NeoBase® Abutments SSC include Neo Abutment Screw and Neo Laboratory Screw



Art. No.	Description	A	B	C
31393	NeoBase® Mono SSC G0.3mm – H3.6mm	3.9mm	0.3mm	4.5mm
31394	NeoBase® Mono SSC G1.5mm – H3.6mm	5.1mm	1.5mm	
31395	NeoBase® Mono SSC G0.3mm – H5.6mm	5.9mm	0.3mm	
31396	NeoBase® Mono SSC G1.5mm – H5.6mm	7.1mm	1.5mm	
31397	NeoBase® Multi SSC G0.3mm – H3.6mm	3.9mm	0.3mm	
31398	NeoBase® Mono SSC G0.3mm – H3.6mm, NP	3.9mm	0.3mm	3.8mm
31399	NeoBase® Mono SSC G0.3mm – H5.6mm, NP	5.9mm		
31400	NeoBase® Multi SSC G0.3mm – H3.6mm, NP	3.9mm		

Includes Neo Abutment Screw NP and Neo Laboratory Screw NP

*See page 16 for ARC offering – custom-made implant prosthetics

NeoBase® Abutments ASC (Angulated Screw Channel)*

also referred to as TiBase

All NeoBase® Abutments ASC include iGO Abutment Screw and iGO Laboratory Screw



Art. No.	Description	A	B	C
31367	NeoBase® Mono ASC G 0.3mm – H3.6mm	3.9mm	0.3mm	4.5mm
31368	NeoBase® Mono ASC G 1.5mm – H3.6mm	5.1mm	1.5mm	
31369	NeoBase® Mono ASC G 0.3mm – H5.6mm	5.9mm	0.3mm	
31370	NeoBase® Mono ASC G 1.5mm – H5.6mm	7.1mm	1.5mm	
31371	NeoBase® Multi ASC G 0.3mm – H3.6mm	3.9mm	0.3mm	
31372	NeoBase® Mono ASC G 0.3mm – H3.6mm, NP	3.9mm	0.3mm	3.8mm
31373	NeoBase® Mono ASC G 0.3mm – H5.6mm, NP	5.9mm		
31374	NeoBase® Multi ASC G 0.3mm – H3.6mm, NP	3.9mm		

Includes iGO Abutment Screw NP and iGO Laboratory Screw NP

*See page 16 for ARC offering – custom-made implant prosthetics

Neoss TiBase Abutments (compatible with Dentsply Sirona®)

All TiBase Abutments include Neo Abutment Screw and Titanium Screw

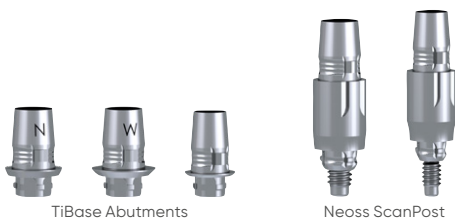

Art. No.	Description	A	B	C
31329	Neoss TiBase N (NB B 3.4 L)	5.3mm	0.6mm	4.5mm
31330	Neoss TiBase W (NB B 4.1 L)		5.0mm	
31345	Neoss TiBase, NP (FX 3.4 S)	5mm	0.3mm	3.9mm
31331	Neoss ScanPost L (TiBase) <i>Includes ScanPost with Screw</i>			
31346	Neoss ScanPost S (TiBase, NP) <i>Includes ScanPost with Screw NP</i>			

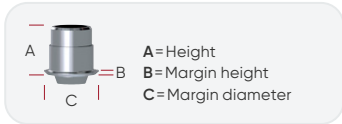

Ti NeoLink®

Titanium NeoLinks include Neo Abutment Screw, Neo Laboratory Screw and Straight Copings

Art. No.	Description	A	B	C
31133	Ti NeoLink® Mono			4.5mm
31134	Ti NeoLink® Multi	3.9mm	0.3mm	
31234	Ti NeoLink® Mono, NP			3.8mm

Includes Neo Abutment Screw Ti NP, Neo Laboratory Screw NP and a set of Preformed Plastic Copings

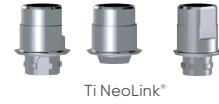

Custom Solutions

Neoss NT Blanks, SSC

Includes Neo Abutment Screw and Neo Laboratory Screw

Art. No.	Description
31375	Neoss NT Blanks Ti SSC, Ø12 mm, SP – 1 pc
31377	Neoss NT Blanks Ti SSC, Ø12 mm, NP – 1 pc

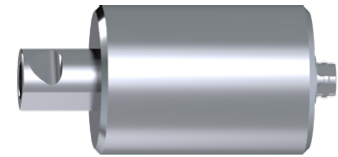

Neoss CM Blanks, SSC

Includes Neo Laboratory Screw

Art. No.	Description
31406	Neoss CM Blanks Ti, Ø12×13 mm, SP – 10 pcs
31405	Neoss CM Blanks Ti, Ø10×15 mm, NP – 5 pc

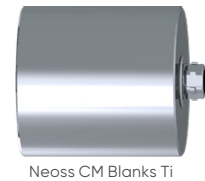

Neoss *Digital Prosthetic Workflow*

ARC Solutions are specialists in the manufacture of custom-made implant prosthetics. ARC Solutions places great value on providing customers with maximum service and delivering reliable products.

Get started and how to order

1. Go to neoss.com/arc
2. Please ensure that you are on the correct country

Turnaround times for design and final parts

- A. Design of restoration 1 business day*
- B. Final part to be manufactured within 2 business days if design file received before 12 noon (UK 11)**
- C. Express mode 1 business day for manufacturing**

* Times for A are applicable for stone model received for scan or intraoral scan file sent (e.g. NeoScan).

** Times for B and C are applicable for all 3 options, as it refers to the manufacturing.

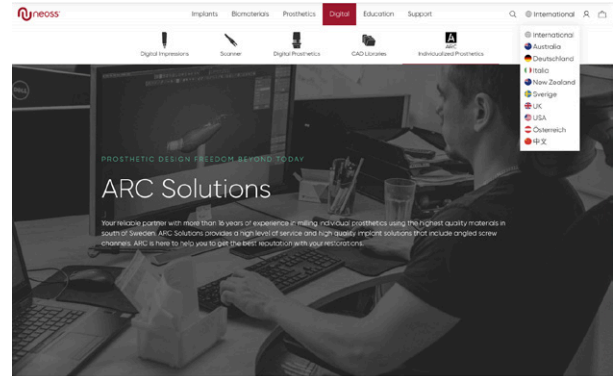

Scenario 1

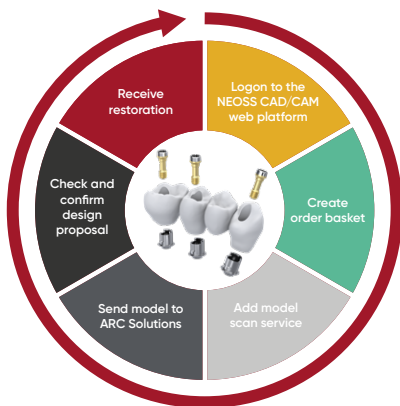

Scenario 2

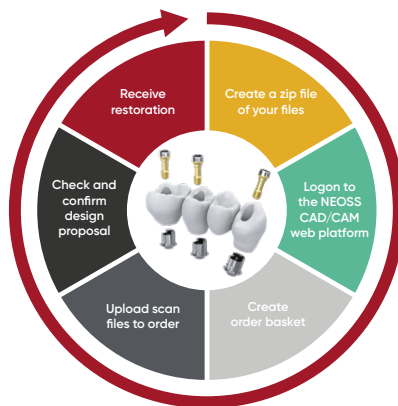

Scenario 3

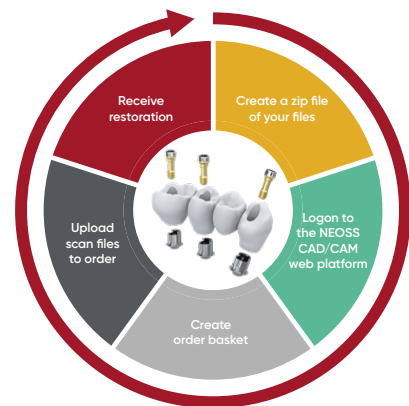

Do you have a model to be scanned?

1. Logon to NEOSS CAD/CAM
2. Create order basket
3. Add model scan service
4. Send model to ARC Solutions
5. Check and confirm design proposal
6. Receive restoration

Do you have 3D scan files?

(STL files of model or intraoral impression)

1. Create a zip file of your files
2. Logon to NEOSS CAD/CAM
3. Create order basket
4. Upload scan files to order
5. Check and confirm design proposal
6. Receive restoration

Do you have ready designed files?

1. Create a zip file of your files
2. Logon to NEOSS CAD/CAM
3. Create order basket
4. Upload scan files to order
5. Receive restoration

	Abutment						Bridge				Bar				
	Ti		CoCr		ZrO		Ti		CoCr		Ti		CoCr		
	SSC	ASC	SSC	ASC	SSC	ASC	SSC	ASC	SSC	ASC	SSC	ASC	SSC	ASC	
Neoss SP	✓	✓	✓	✓	✓	✓	✓	✓	✓	✓	✓	✓	✓	✓	✓
Neoss NP	✓	✓	✓	✓	✓	✓	✓	✓	✓	✓	✓	✓	✓	✓	✓
Neoss Access							✓	✓	✓	✓	✓	✓	✓	✓	✓
Neoss Multi-Unit							✓	✓	✓	✓	✓	✓	✓	✓	✓

SSC= Straight Screw Channel
ASC= Angulated Screw Channel

ARC Solutions

ARC Solutions offers an attractive bundle of custom-milled titanium abutments or bars in combination with custom-milled zirconia. ARC Solutions also offers a bundle of NeoBases with custom-milled zirconia.

Crown Zirconia on NeoBase

Zirconia available in Mono or Multi Layer.

NeoBases available as straight or angulated screw channel.



NeoBase SSC & Crown Zirconia

Crown Zirconia on Custom Abutment

Zirconia available as Mono or Multi Layer.

Custom Abutments can be designed freely for emergence profile and with straight or angulated screw channel

Crowns can be designed with or without access hole for prosthetic screw



Custom Base Ti ASC & Crown Zirconia with hole access



Custom Base Ti SSC & Crown Zirconia without access hole

Bridge Zirconia on NeoBases

Zirconia available as Mono or Multi Layer.

NeoBases available as straight or angulated screw channel



NeoBase ASC & Bridge Zirconia

OneToOne Ti Bar & Zirconia Bridge

OneToOne Ti Bar & Zirconia Bridge Mono Layer 2 – 16 Units

OneToOne Ti Bar & Zirconia Bridge Multi Layer 2 – 16 Units



OneToOne Ti Bar & Zirconia Bridge

Other products milled or additive printed by ARC



Custom Abutments
SSC/ASC



Partial Titanium Bridges
SSC/ASC



Full Arch Bridges
SSC/ASC



Additive CoCr Bridges
SSC/ASC



Custom Bars

Scan the QR code
or visit neoss.com/arc
to place your order.



ARC
Solutions

Experience *easy-to-use full arch flexibility* with predictable results using Neoss4+ treatment solution

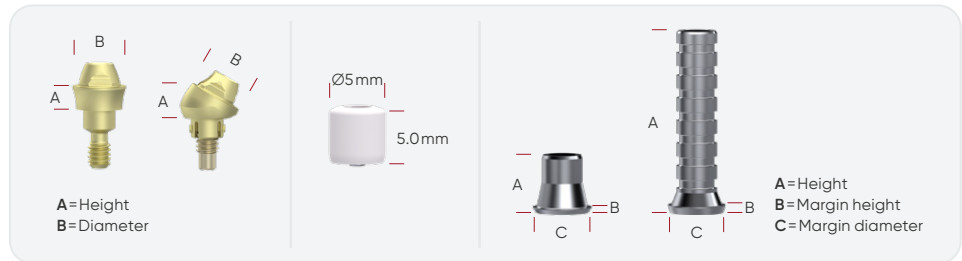

Neoss4+ treatment solution

Multi-Unit Abutments **NEW**

*Clinical screw fixed within the Multi-Unit Abutment
Healing Cap and Replica needs to be ordered separately*

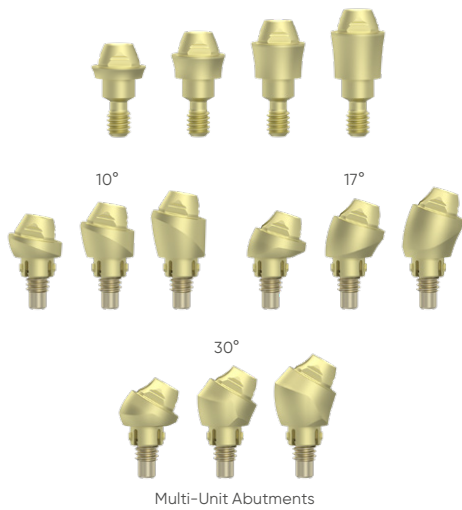

Multi-Unit Abutments



Multi-Unit Healing Cap



Multi-Unit Impression Coping Open tray



Multi-Unit Impression Coping Closed tray



Multi-Unit Replica



Multi-Unit NeoBase* SSC



Multi-Unit Provisional Abutment Ti



Multi-Unit NeoBase* ASC



Multi-Unit Scan Body



Analog for Printed Model Neoss* Multi-Unit

Art. No.	Description	A	B	C
31411	Multi-Unit Abutment 1.0mm	1mm	4.6mm	
31412	Multi-Unit Abutment 2.0mm	2mm		
31413	Multi-Unit Abutment 3.0mm	3mm		
31414	Multi-Unit Abutment 4.0mm	4mm		
31425	Multi-Unit Abutment 10° 2.0mm	2mm	4.6mm	
31426	Multi-Unit Abutment 10° 3.0mm	3mm		
31427	Multi-Unit Abutment 10° 4.0mm	4mm		
31429	Multi-Unit Abutment 17° 2.5mm	2.5mm	4.6mm	
31430	Multi-Unit Abutment 17° 3.5mm	3.5mm		
31431	Multi-Unit Abutment 17° 4.5mm	4.5mm		
31433	Multi-Unit Abutment 30° 3.0mm	3mm	4.6mm	
31434	Multi-Unit Abutment 30° 4.0mm	4mm		
31435	Multi-Unit Abutment 30° 5.0mm	5mm		
31440	Multi-Unit Healing Cap	5mm	5mm	
31442	Multi-Unit Impression Coping Open tray 6mm*			
31443	Multi-Unit Impression Coping Closed tray 10mm*			
31444	Multi-Unit Replica – 5 pcs			
31445	Multi-Unit Provisional Abutment Ti	15.7mm	0.7mm	5mm
31446	Multi-Unit NeoBase* SSC G 0.5mm – H 4.5mm	5mm	0.5mm	5.1mm
31447	Multi-Unit NeoBase* ASC G 0.5mm – H 4.5mm iGO	5mm	0.5mm	5.1mm
31450	Multi-Unit Scan Body			
91074	Analog for Printed Model Neoss* Multi-Unit			

**Not co-packed and should be ordered separately*

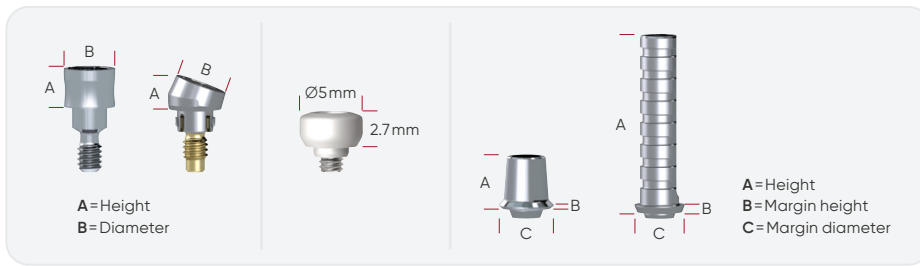

Access Abutments

Clinical screw fixed within the Multi-Unit Abutment

Art. No.	Description	A	B
<i>All Access Abutments include Abutment and a Healing Abutment</i>			
31238	Access Abutment 1.5 mm	1.5mm	4 mm
31215	Access Abutment 3.0 mm	3 mm	
31216	Access Abutment 4.0 mm	4 mm	
31218	Access Abutment 6.0 mm	6 mm	
31219	Access Abutment 10° 2.6 mm	2.6mm	4 mm
31243	Access Abutment 10° 4.6 mm	4.6 mm	
31221	Access Abutment 20° 2.6 mm	2.6 mm	
31244	Access Abutment 20° 4.6 mm	4.6 mm	
31223	Access Abutment 30° 2.9 mm	2.9 mm	
31245	Access Abutment 30° 4.9 mm	4.9 mm	
31225	Access Impression Coping 8 mm and Replica <i>Includes Coping, Screw, Replica, Extension Tube for Open Tray and Plastic Cap for Closed Tray Technique</i>		
31366	Access Impression Coping 13 mm and Replica		
90183	Scan Body Neoss® Access (IO 1B-A)		

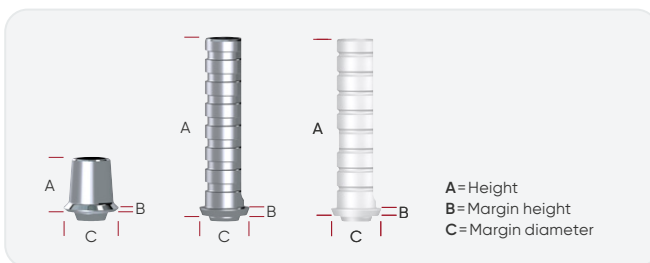

Art. No.	Description	A	B	C
31226	Access Ti NeoLink® Multi	4.3mm	0.3mm	4.5mm
31227	Access Gold NeoLink® Multi <i>31226 and 31227 include NeoLink®, Prosthetic Screw, Provisional/Laboratory Screw and a Plastic Coping</i>	4.7mm	0.7mm	4.5mm
90207	Access Equator Abutment Kit 0.5 mm			
90208	Access Equator Abutment Kit 1.5 mm			
31301	Access Provisional Ti Abutment Multi <i>Includes Provisional/Laboratory Screw and Straight Coping</i>	15.7 mm	0.7 mm	4.5 mm
31266	Access Burnout Abutment Multi – 2 pcs <i>Includes Straight Coping</i>			

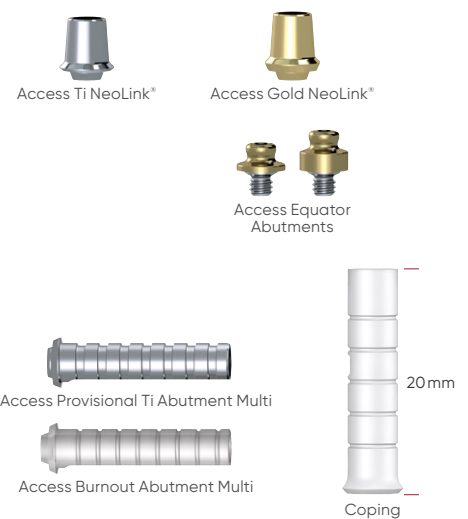

Multi-Unit/Access Screws

Art. No.	Description
31229	Multi-Unit/Access Neo Prosthetic Screw – 1pc
31257	Multi-Unit /Access Neo Provisional/Laboratory Screw – 5 pcs
31265	Multi-Unit/Access Neo Laboratory Screw Long – 5 pcs
31348	Multi-Unit/Access iGO Prosthetic Screw – 1pc
31351	Multi-Unit/Access iGO Laboratory Screw – 1pc

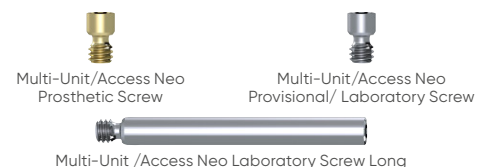

Design control with *total flexibility*

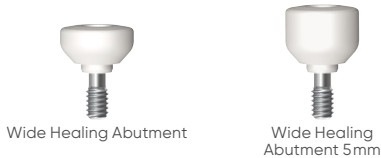
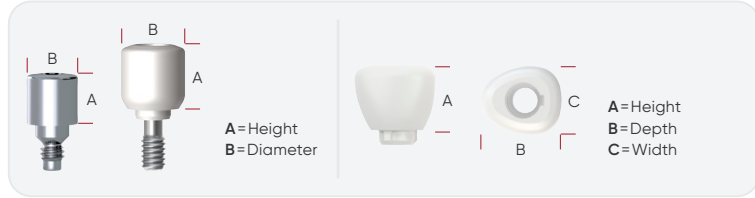

Healing Abutments

Esthetic Healing Abutments with ScanPeg

All Esthetic Healing Abutments include Titanium Screw and a ScanPeg

Art. No.	Description	A	B	C
31360	Esthetic Healing Abutment with ScanPeg – Wide Incisor	5mm	5.7mm	6.1mm
31361	Esthetic Healing Abutment with ScanPeg – Narrow Incisor		5.2mm	5mm
31362	Esthetic Healing Abutment with ScanPeg – Canine		6.3mm	5.4mm
31363	Esthetic Healing Abutment with ScanPeg – Pre-molar		6.8mm	5.8mm
31364	Esthetic Healing Abutment with ScanPeg – Molar		7.8mm	7.3mm

Healing Abutments

Art. No.	Description	A	B
31159	Healing Abutment Ti 2mm	2mm	4mm
31160	Healing Abutment Ti 4mm	4mm	
31161	Healing Abutment Ti 6mm	6mm	
31162	Healing Abutment Ti 8mm	8mm	
31163	Healing Abutment Ti 10mm	10mm	
31148	Healing Abutment PEEK 5mm with Screw	5mm	5mm
31320	Healing Abutment PEEK 5mm with Screw, NP		4mm
31321	Wide Healing Abutment PEEK 3.3mm with Screw	3.3mm	6.5mm
31335	Wide Healing Abutment PEEK 5mm with Screw	5mm	6.5mm
31410	Healing Abutment PEEK 2.7 mm with Screw	2.7mm	5mm

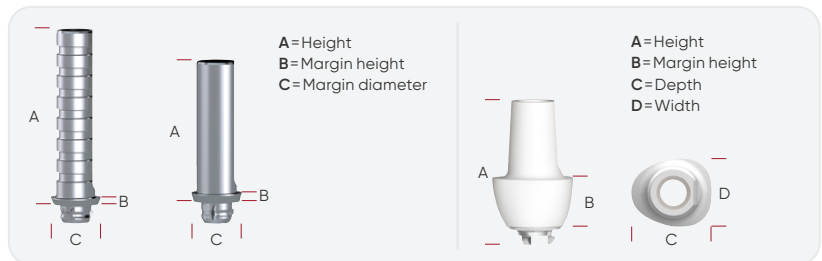

Provisional Abutments

Esthetic Tissue Formers

All Esthetic Tissue Formers include Provisional Screw

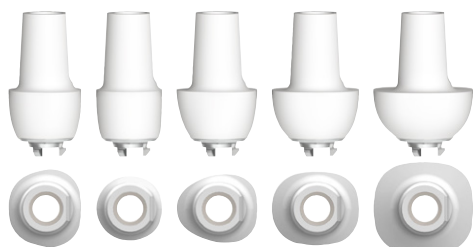

Art. No.	Description	A	B	C	D
31340	Esthetic Tissue Former – Wide Incisor	10mm	4mm	5.7mm	6.1mm
31341	Esthetic Tissue Former – Narrow Incisor			5.2mm	5mm
31342	Esthetic Tissue Former – Canine			6.3mm	5.3mm
31343	Esthetic Tissue Former – Pre-molar			6.8mm	5.8mm
31344	Esthetic Tissue Former – Molar			7.8mm	7.3mm

Provisional Titanium Abutments

All Provisional Abutments include Provisional Screw and Coping

Art. No.	Description	A	B	C
31267	Provisional Ti Abutment Mono			
31268	Provisional Ti Abutment Multi	15.7mm	0.7mm	4.5mm
31332	Provisional Ti Abutment Mono – Cement Retained			
31241	Provisional Ti Abutment, NP	10.7mm	0.7mm	3.8mm

Includes Provisional Titanium Abutment, Provisional Screw NP and Neo Laboratory Screw NP

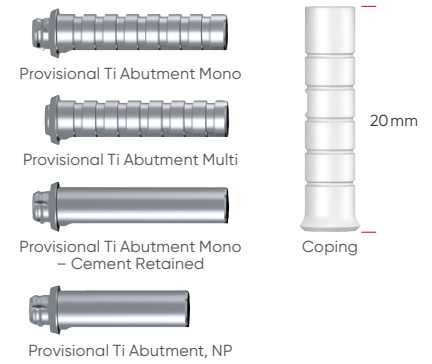

Final Abutments

Prepable Titanium Abutments

All Prepable Abutments include Neo Abutment Screw and Neo Laboratory Screw

Art. No.	Description	A	B	C	D	E
31280	Prepable Ti Abutment 1.5mm 0° – Wide Incisor	8.5mm	2.5mm	1.5mm	5.8mm	6.5mm
31281	Prepable Ti Abutment 1.5mm 15° – Wide Incisor					
31282	Prepable Ti Abutment 1mm 0° – Narrow Incisor	8mm	2mm	1mm	5mm	5.1mm
31283	Prepable Ti Abutment 1mm 15° – Narrow Incisor					
31284	Prepable Ti Abutment 3mm 0° – Narrow Incisor	10mm	4mm	3mm	5.1mm	5.1mm
31285	Prepable Ti Abutment 3mm 15° – Narrow Incisor					
31286	Prepable Ti Abutment 3mm 0° – Canine	10mm	4mm	3mm	6.7mm	5.4mm
31305	Prepable Ti Abutment 1.5mm 0° – Pre-molar	7mm	2mm	1.5mm	6.9mm	5.7mm
31287	Prepable Ti Abutment 3mm 0° – Pre-molar	9mm	3mm	3mm	6.9mm	5.7mm
31306	Prepable Ti Abutment 1.5mm 0° – Molar	7mm	2mm	1.5mm	7.8mm	7.1mm
31288	Prepable Ti Abutment 3mm 0° – Molar	9mm	3mm	3mm	7.8mm	7.1mm
31201	Prepable Ti Abutment 1mm 0°, NP	8mm	2mm	1mm	4mm	
31202	Prepable Ti Abutment 1mm 15°, NP					



Prepable Titanium Abutments, Alternative Emergence Profiles

Art. No.	Description	A	B	C	D	E
31317	Prepable Ti Abutment 2mm 0° – Wide Emergence <i>Includes Neo Abutment Screw, Neo Laboratory Screw, specific Cover Screw and specific Healing Abutment PEEK with Screw. Compatible with Implant diameters Ø5.0 – 6.5mm</i>	9mm	2mm	2mm	7.9mm	7.1mm
31318	Prepable Ti Abutment 1.5mm 0° – Narrow Emergence	8.5mm	2mm	1.5mm	4.4mm	4.5mm
31319	Prepable Ti Abutment 1.5mm 15° – Narrow Emergence <i>All Narrow Emergence Prepable Abutments include Neo Abutment Screw and Neo Laboratory Screw. Only use with Ø3.5 and Ø4.0 mm implants</i>					

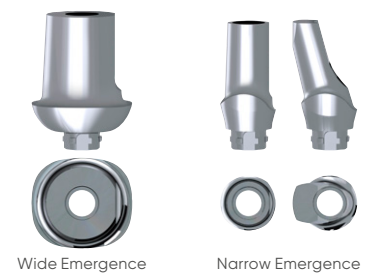



Zirconia Abutments

All Zirconia Abutments include separate Zirconia Coping, Ti NeoLink® Mono, Neo Abutment Screw and Neo Laboratory Screw

Art. No.	Description	A	B	C	D	E
31290	Zirconia Abutment – Wide Incisor	9mm	2.5mm	1.5mm	5.8mm	6.4mm
31291	Zirconia Abutment – Narrow Incisor				5.4mm	5.1mm
31292	Zirconia Abutment – Canine				6.2mm	5.8mm
31293	Zirconia Abutment – Pre-molar		2mm	2mm	6.4mm	5.5mm
31294	Zirconia Abutment – Molar		7.2mm	6.7mm		

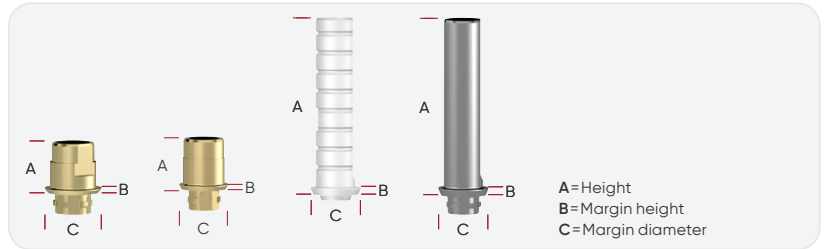

Final Restorations – Casting

Gold NeoLink® (Direct Casting)

Gold NeoLinks include Neo Abutment Screw, Neo Laboratory Screw and Straight Copings



Art. No.	Description	A	B	C
31102	Gold NeoLink® Mono	4.0mm	0.4mm	4.5mm
31103	Gold NeoLink® Multi			3.8mm
31199	Gold NeoLink® Mono, NP <i>Includes Neo Abutment Screw Ti NP, Neo Laboratory Screw NP and a set of Preformed Plastic Copings</i>			

CoCr Abutments (Indirect Casting)

CoCr Abutments include Neo Abutment Screw, Neo Laboratory Screw and Straight Coping

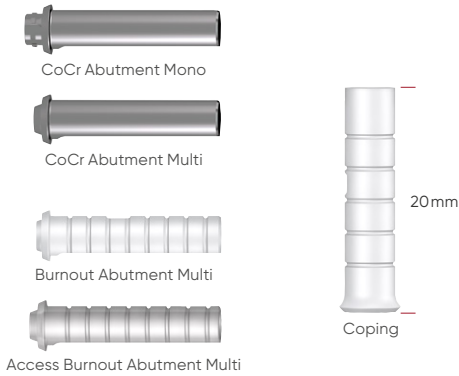

Art. No.	Description	A	B	C
31269	CoCr Abutment Mono	15.7mm	0.7mm	4.5mm
31260	CoCr Abutment Multi			

Burnout Abutments (Direct Casting)

31157 and 31266 include Straight Coping

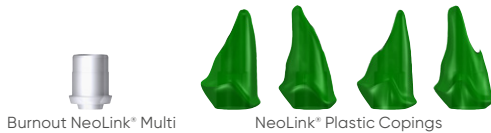

Art. No.	Description	A	B	C
31157	Burnout Abutment Multi – 2 pcs	4.3mm		3.8mm
31266	Access Burnout Abutment Multi – 2 pcs			
31255	Burnout NeoLink® Multi NP – 2 pcs <i>Includes set of Preformed Plastic Copings</i>			

Overdenture Abutments

Equator Abutments

All kits include Equator Abutment, Housing with processing Cap, Protector Disk, Standard, Strong, Soft and Extra Soft Retention caps

Art. No.	Description
90201	Neoss Equator Abutment Kit 1mm
90202	Neoss Equator Abutment Kit 2mm
90242	Neoss Equator Abutment Kit 2mm, NP
90203	Neoss Equator Abutment Kit 3mm
90243	Neoss Equator Abutment Kit 3mm, NP
90204	Neoss Equator Abutment Kit 4mm
90244	Neoss Equator Abutment Kit 4mm, NP
90205	Neoss Equator Abutment Kit 5mm
90206	Neoss Equator Abutment Kit 6mm
90207	Access Equator Abutment Kit 0.5mm
90208	Access Equator Abutment Kit 1.5mm
90210	Neoss Equator Cap and Housing Kit
90215	Neoss Equator Cap and Housing Kit – Extended Divergence
90211	Neoss Equator Cap Standard Retention, White – 2 pcs
90212	Neoss Equator Cap Strong Retention, Violet – 2 pcs
90213	Neoss Equator Cap Soft Retention, Pink – 2 pcs
90214	Neoss Equator Cap Extra Soft Retention, Yellow – 2 pcs
90220	Neoss Equator Impression Coping & Replica – 2 sets
90222	Neoss Equator Protector Disk – 10 pcs
90232	Neoss Equator Cap Tool



Bar Abutment

Art. No.	Description
31168	Bar Abutment Gold <i>Includes Abutment, Neo Abutment Screw and Neo Laboratory Screw</i>
31261	Bar Abutment Ti 14 mm <i>Includes Neoss Abutment Screw and Laboratory Screw</i>



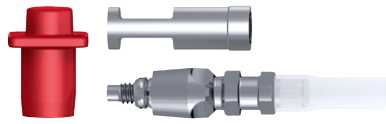

Impression Coping and Replica

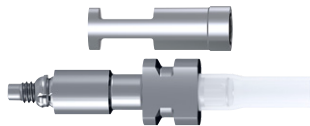

Impression Coping Open Tray and Replica

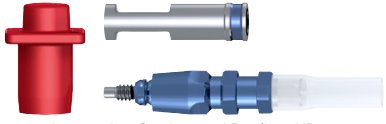

Impression Coping and Replica, NP



Access Impression Coping and Replica



Impression Coping Cap

Impression Coping Extension Tube

Impressions & Replicas

Impressions Copings

Art. No. Description

31170	Impression Coping 8mm and Replica
31145	Impression Coping 11mm and Replica
31183	Impression Coping 18 mm and Replica <i>31170, 31145 and 31183 include Coping, Screw, Replica, Extension Tube for Open Tray and Plastic Cap for Closed Tray Technique</i>
31302	Impression Coping Open Tray 8mm and Replica
31185	Impression Coping Open Tray 13 mm and Replica <i>31302 and 31185 include Coping, Screw, Replica and Extension Tube</i>
31197	Impression Coping 11mm and Replica, NP <i>Includes Coping, Screw, Replica, Extension Tube for Open Tray and Plastic Cap for Closed Tray Technique</i>
31442	Multi-Unit Impression Coping Open tray 6 mm*
31443	Multi-Unit Impression Coping Closed tray 10 mm*
31366	Access Impression Coping 13 mm and Replica
31186	Impression Coping Cap Closed Tray – 10 pcs
31262	Impression Coping Extension Tube – 20 pcs

**Not co-packed and should be ordered separately*

Replicas

Art. No. Description

31444	Multi-Unit Replica – 5 pcs*
31231	Access Replica – 5 pcs
31146	Implant Replica – 5 pcs
31198	Implant Replica, NP – 5 pcs
31304	Implant Replica, NP – 1pc
31166	Protection Replica – 1pc

**Not co-packed and should be ordered separately*

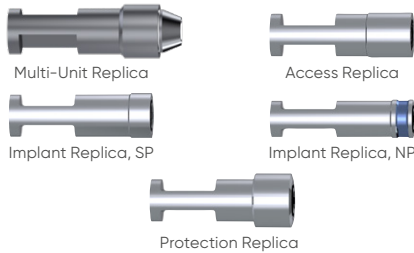

Multi-Unit Replica

Access Replica

Implant Replica, SP

Implant Replica, NP

Protection Replica

Screws

Art. No. Description

31258	Neo Abutment Screw, SP – 1pc
31259	Neo Abutment Screw, SP – 5 pcs
31240	Neo Abutment Screw Ti, NP – 1pc
31149	Neo Laboratory Screw, SP – 5 pcs
31239	Neo Laboratory Screw, NP – 1pc
31303	Neo Laboratory Screw Long, SP – 5 pcs
31347	iGO Abutment Screw, SP – 1pc
31349	iGO Abutment Screw, NP – 1pc
31348	Multi-Unit/Access iGO Prosthetic Screw – 1pc
31350	iGO Laboratory Screw, SP – 1pc
31352	iGO Laboratory Screw, NP – 1pc
31351	Multi-Unit/Access iGO Laboratory Screw – 1pc
31229	Multi-Unit/Access Neo Prosthetic Screw – 1pc
31257	Multi-Unit/Access Neo Provisional/Laboratory Screw – 5 pcs
31265	Multi-Unit/Access Neo Laboratory Screw Long – 5 pcs

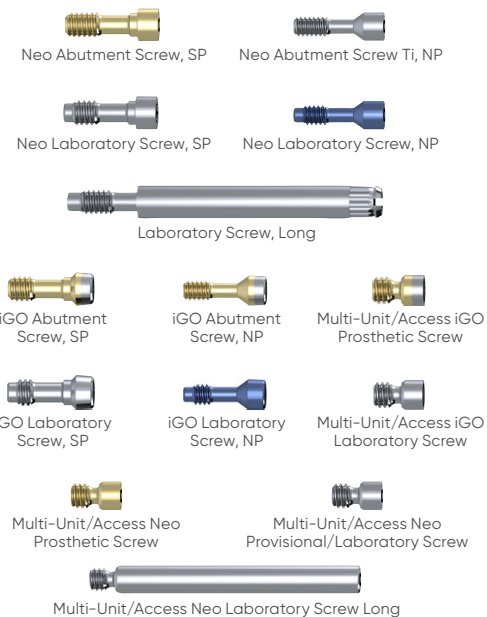

Neo Abutment Screw, SP

Neo Abutment Screw Ti, NP

Neo Laboratory Screw, SP

Neo Laboratory Screw, NP

Laboratory Screw, Long

iGO Abutment Screw, SP

iGO Abutment Screw, NP

Multi-Unit/Access iGO Prosthetic Screw

iGO Laboratory Screw, SP

iGO Laboratory Screw, NP

Multi-Unit/Access iGO Laboratory Screw

Multi-Unit/Access Neo Prosthetic Screw

Multi-Unit/Access Neo Provisional/Laboratory Screw

Multi-Unit/Access Neo Laboratory Screw Long

The instruments *you need*

Drills

Art. No. Description

41153	Round Bur Ø1.8mm	
41152	Lance Drill Ø1.5×3/5/7mm	
41170	Pilot Drill Ø2.2/3.0 mm	
41154	Twist Drill, Straight Ø2.2×7 – 17 mm	
41156	Twist Drill, Straight Ø2.85×7 – 17 mm	
41157	Twist Drill, Straight Ø3.0×7 – 17 mm	
41158	Twist Drill, Straight Ø3.2×7 – 17 mm	
41159	Twist Drill, Straight Ø3.4×7 – 17 mm	
41160	Twist Drill, Straight Ø3.6×7 – 17 mm	
41161	Twist Drill, Straight Ø3.9×7 – 17 mm	
41162	Twist Drill, Straight Ø4.1×7 – 17 mm	
41163	Twist Drill, Straight Ø4.4×7 – 17 mm	
41164	Twist Drill, Straight Ø4.6×7 – 17 mm	
41165	Twist Drill, Straight Ø4.9×7 – 17 mm	
41166	Twist Drill, Straight Ø5.1×7 – 17 mm	
41205	Twist Drill, Straight Ø6.0×7 – 11 (13)mm	
41193	Drill Kit, Straight Implants Ø3.5 – 5.0 <i>Includes Twist Drills Ø2.2, 3.0, 3.4, 3.9 and 4.4</i>	
41172	Twist Drill, Tapered Ø3.0×7 – 17 mm	1.9mm
41173	Twist Drill, Tapered Ø3.4×7 – 17 mm	2.3mm
41174	Twist Drill, Tapered Ø3.9×7 – 17 mm	2.8mm
41175	Twist Drill, Tapered Ø4.4×7 – 17 mm	Ø 3.3mm
41176	Twist Drill, Tapered Ø4.9×7 – 17 mm	3.8mm
41206	Twist Drill, Tapered Ø5.5×7 – 17 mm	4.3mm
41204	Twist Drill, Tapered Ø5.5×7 – 11 (13)mm	4.3mm
41192	Drill Kit, Tapered Implants Ø3.5 – 5.0 <i>Includes Twist Drills Ø2.2 S, 3.0 T, 3.4 T, 3.9 T and 4.4 T</i>	
41177	Drill Kit, Edge Implants Ø3.5 – 5.0 <i>Includes Twist Drills Ø2.2 S, 3.0 T, 3.4 T, 3.9 T and 4.4 T</i>	
41142	Drill Stop 7 mm Ø2.2, 3.0, 3.4, 3.9 and 4.4 mm	
41143	Drill Stop 9 mm Ø2.2, 3.0, 3.4, 3.9 and 4.4 mm	
41144	Drill Stop 11 mm Ø2.2, 3.0, 3.4, 3.9 and 4.4 mm	
41145	Drill Stop 13 mm Ø2.2, 3.0, 3.4, 3.9 and 4.4 mm	
41146	Drill Stop 15 mm Ø2.2, 3.0, 3.4, 3.9 and 4.4 mm	
41215	Twist Drill, Straight Ø2.2×7 – 17 mm	
41216	Twist Drill, Straight Ø2.85×7 – 17 mm	
41217	Twist Drill, Straight Ø3.0×7 – 17 mm	
41218	Twist Drill, Straight Ø3.2×7 – 17 mm	
41219	Twist Drill, Straight Ø3.4×7 – 17 mm	
41220	Twist Drill, Straight Ø3.6×7 – 17 mm	
41221	Twist Drill, Straight Ø3.9×7 – 17 mm	
41222	Twist Drill, Straight Ø4.1×7 – 17 mm	
41223	Twist Drill, Straight Ø4.4×7 – 17 mm	
41224	Twist Drill, Straight Ø4.6×7 – 17 mm	
41225	Twist Drill, Straight Ø4.9×7 – 17 mm	
41226	Twist Drill, Straight Ø5.1×7 – 17 mm	

Single Use

Multiple Use



Round Bur



Lance Drill



Pilot Drill



Twist Drill, Straight



Twist Drill, Tapered



Drill Stop



Twist Drill, Straight - Short



Twist Drill, Tapered - Short



Countersink



Countersink, Straight



Countersink, Tapered



Countersink, Edge



Screw Tap

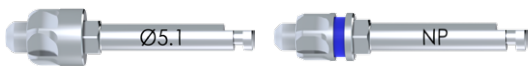

Bone Profiler



Bone Remover Cover Screw

Art. No. Description

41233	Drill Kit, Straight Implants Ø3.5 – 5.0 <i>Includes Twist Drills Ø2.2, 3.0, 3.4, 3.9 and 4.4</i>	
41184	Drill Kit, Straight – Short 7 – 13 mm <i>Includes Twist Drills Ø2.2, 3.0, 3.4, 3.9, 4.4 and 4.9</i>	
41227	Twist Drill, Tapered Ø3.0×7 – 17 mm	19mm
41228	Twist Drill, Tapered Ø3.4×7 – 17 mm	2.3mm
41229	Twist Drill, Tapered Ø3.9×7 – 17 mm	2.8mm
41230	Twist Drill, Tapered Ø4.4×7 – 17 mm	3.3mm
41231	Twist Drill, Tapered Ø4.9×7 – 17 mm	3.8mm
41232	Twist Drill, Tapered Ø5.5×7 – 17 mm	4.3mm
41235	Drill Kit, Tapered Implants Ø3.5 – 5.0 <i>Includes Twist Drills Ø2.2S, 3.0T, 3.4T, 3.9T and 4.4T</i>	
41191	Drill Kit Tapered – Short 7 – 13 mm <i>Includes Twist Drills Ø2.2S, 3.0T, 3.4T, 3.9T, 4.4T, and 4.9T</i>	
41236	Drill Kit, Edge Implants Ø3.5 – 5.0 <i>Includes Twist Drills Ø2.2S, 3.0T, 3.4T, 3.9T and 4.4T</i>	
41139	Countersink, Straight Ø3.25	2.7mm
41110	Countersink, Straight Ø3.5	2.9mm
41111	Countersink, Straight Ø4.0	3.3mm
41112	Countersink, Straight Ø4.5	3.5mm
41133	Countersink, Straight Ø5.0	4.3mm
41127	Countersink, Straight Ø5.5	4.7mm
41178	Countersink, Tapered Ø3.5	2.0mm
41179	Countersink, Tapered Ø4.0	2.8mm
41180	Countersink, Tapered Ø4.5	3.3mm
41181	Countersink, Tapered Ø5.0	3.7mm
41182	Countersink, Tapered Ø5.5	4.2mm
41210	Countersink, Edge Ø3.5	1.8mm
41211	Countersink, Edge Ø4.0	2.6mm
41212	Countersink, Edge Ø4.5	3.0mm
41213	Countersink, Edge Ø5.0	3.5mm
41202	Countersink Ø6.0	4.8mm
41201	Countersink Ø6.5	5.2mm
41113	Screw Tap Ø3.5	
41114	Screw Tap Ø4.0	
41115	Screw Tap Ø4.5	
41134	Screw Tap Ø5.0	
41126	Screw Tap Ø5.5	
41140	Screw Tap Ø3.25	
41237	Bone Profiler Ø5.1mm, SP	
41238	Bone Profiler Ø6.6mm, SP	
41239	Bone Profiler Ø4.1 mm, NP	
41240	Bone Remover Cover Screw, SP	
41241	Bone Remover Cover Screw, NP	

Multiple Use

Kits

Surgical & Prosthetic Trays

Art. No. Description

51180	Neoss Prosthetic Tray – Neo
51186	Neoss ProActive® Implant System Box
51189	Neoss Surgical and Prosthetic Tray – ProActive® Edge
51188	Neoss Surgical and Prosthetic Tray – ProActive® Tapered
51187	Neoss Surgical and Prosthetic Tray – ProActive® Straight



Neoss Prosthetic Tray – Neo

Neoss ProActive® Implant System Box

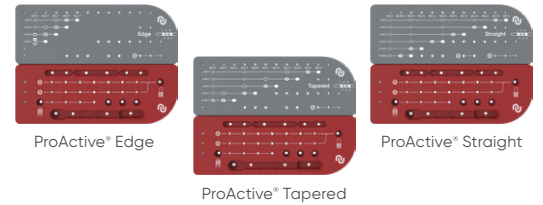

ProActive® Edge

ProActive® Tapered

ProActive® Straight

Surgical & Prosthetic Kits with instruments and drills

Art. No. Description

51181	Neoss Prosthetic Instrument Kit – Neo <i>Includes Prosthetic Tray, Ratchet, Screwdriver Machine 22mm, Screwdriver Machine 32mm, Screwdriver Manual 15mm and Manual Handle</i>
41151	Surgical Instrument Kit <i>Includes art no 41120, 51118, 51119, 51144, 51139, 51140, 51125 and 51126</i>
41254	Drill and Surgical Instrument Kit, Edge Implants Ø3.5 – 5.0 <i>Single use twist drills. Includes art no 41177, 41210, 41211, 41212, 41213, 41237, 41238, 41240, 41151, 41153, 41152, 41170, 51121, 51137, 51141, 51186, 51189 and 51190</i>
41253	Drill and Surgical Instrument Kit, Edge Implants Ø3.5 – 5.0 <i>Multiple use twist drills. Includes art no 41236, 41210, 41211, 41212, 41213, 41237, 41238, 41240, 41151, 41153, 41152, 41170, 51121, 51137, 51141, 51186, 51189 and 51190</i>
41252	Drill and Surgical Instrument Kit, Tapered Implants Ø3.5 – 5.0 <i>Single use twist drills. Includes art no 41192, 41158, 41160, 41162, 41164, 41178, 41179, 41180, 41181, 41151, 41153, 41152, 41170, 41237, 41238, 41240, 51121, 51137, 51141, 51186, 51188 and 51190</i>
41251	Drill and Surgical Instrument Kit, Tapered Implants Ø3.5 – 5.0 <i>Multiple use twist drills. Includes art no 41235, 41218, 41220, 41222, 41224, 41237, 41238, 41240, 41178, 41179, 41180, 41181, 41151, 41153, 41152, 41170, 51121, 51137, 51141, 51186, 51188 and 51190</i>
41248	Drill and Surgical Instrument Kit, Straight Implants Ø3.5 – 5.0 <i>Single use twist drills. Includes art no 41193, 41158, 41160, 41162, 41164, 41110, 41111, 41112, 41133, 41151, 41170, 41153, 41152, 41237, 41238, 41240, 51121, 51137, 51141, 51186, 51187 and 51190</i>
41247	Drill and Surgical Instrument Kit, Straight Implants Ø3.5 – 5.0 <i>Multiple use twist drills. Includes art no 41233, 41218, 41220, 41222, 41224, 41110, 41111, 41112, 41133, 41151, 41170, 41153, 41152, 41237, 41238, 41240, 51121, 51137, 51141, 51186, 51187 and 51190</i>
41250	Drill and Surgical Instrument Kit, Straight Implants NP Ø3.25 <i>Single use twist drills. Includes art no 41154, 41156, 41157, 41139, 51142, 51145, 41241, 41239, 41170, 41153, 41152, 51121, 51137, 41120, 51144, 51125, 51139, 51140, 51141, 51126, 51190, 51186 and 51187</i>
41249	Drill and Surgical Instrument Kit, Straight Implants NP Ø3.25 <i>Multiple use twist drills. Includes art no 41215, 41216, 41217, 41139, 51142, 51145, 41241, 41239, 41170, 41153, 41152, 51121, 51137, 41120, 51144, 51125, 51139, 51140, 51141, 51126, 51190, 51186 and 51187</i>
41256	Drill and Surgical Instrument Add-On-Kit, Straight Implant Ø3.25 <i>Single use twist drills. Includes art no 41156, 41239, 41241, 41139, 51142 and 51145</i>
41255	Drill and Surgical Instrument Add-On-Kit, Straight Implant Ø3.25 <i>Multiple use twist drills. Includes art no 41216, 41239, 41241, 41139, 51142 and 51145</i>



Neoss Prosthetic Instrument Kit – Neo



Drill and Surgical Instrument Kit, Edge



Drill and Surgical Instrument Kit, Tapered



Drill and Surgical Instrument Kit, Straight



Drill and Surgical Instrument Kits also includes the prosthetic instruments and a Depth Gauge Probe. All in one box for your convenience.



Neoss® Guide Kit



Implant Mount



Sleeve



Implant Inserters

Guide

Art. No. Description

51154	Neoss® Guide Kit Ø3.5 – Ø6.0 <i>(Neoss® Implants Ø3.5 – Ø6.0mm, 7 – 15mm lengths.) Includes 5 × Drill-Hubs, 2 × Countersink Conduits, 4 × Implant Mount Ø5.0 S9, 2 × Implant Mount Ø6.0 S9, 7 × Guide Keys, 3 × Guide Key Adapter, 1 × Holder Guide Key Adapter. Spare parts available, contact local representative for details</i>
51173	Neoss® Guide – Implant Mount SP, Ø5.0 S9 – 2 pcs
51174	Neoss® Guide – Implant Mount SP, Ø6.0 S9 – 2 pcs
51156	Neoss® Guide – Sleeve Ø5.0 – 10 pcs
51157	Neoss® Guide – Sleeve Ø6.0 – 5 pcs
51155	Neoss® Guide – Implant Inserters, SP <i>For partially guided only, see IFU</i>

Neoss® Guide Kit – SPARE PARTS

Art. No. Description

51160	Neoss® Guide – Drill-Hub I
51161	Neoss® Guide – Drill-Hub II
51162	Neoss® Guide – Drill-Hub III
51163	Neoss® Guide – Drill-Hub IV
51164	Neoss® Guide – Drill-Hub V
51165	Neoss® Guide – Guide Key Ø2.2/2.85
51166	Neoss® Guide – Guide Key Ø3.0/3.2
51167	Neoss® Guide – Guide Key Ø3.4/3.6
51168	Neoss® Guide – Guide Key Ø3.9/4.1
51169	Neoss® Guide – Guide Key Ø4.4/4.6
51170	Neoss® Guide – Guide Key Ø4.9/5.1
51178	Neoss® Guide – Guide Key Ø5.5
51171	Neoss® Guide – Countersink Conduit Ø5.0
51172	Neoss® Guide – Countersink Conduit Ø6.0
51176	Neoss® Guide – Guide Key Adapter – 2 pcs
51177	Neoss® Guide – Holder Guide Key Adapter
51158	Drill Sleeve Ø2.2 – 10 pcs



Demo Kit

Art. No. Description

61150	King Size Dummy Kit <i>Includes Neoss® Straight, Tapered and Edge Implants, implant inserter, screwdriver, abutment screw, NeoLink® Abutment, Esthetic Healing Abutment Narrow Incisor with ScanPeg and crown</i>
-------	--



King Size Dummy Kit

Instruments

Art. No. Description

51137	Implant Inserter, SP 17 mm
51118	Implant Inserter, SP 22 mm
51119	Implant Inserter, SP 32 mm
51145	Implant Inserter, NP 24 mm
51142	Implant Inserter, NP 32 mm
51139	Neo Screwdriver, Machine 22 mm
51140	Neo Screwdriver, Machine 32 mm
51141	Neo Screwdriver, Manual 15 mm
51183	iGO Screwdriver, Machine 22 mm
51184	iGO Screwdriver, Machine 32 mm
51125	Direction/Depth Gauge – 4 pcs
41120	Drill Extender
51190	Depth Gauge Probe
51121	Ratchet
51126	Manual Handle
51191	Insertion Handle – Large
51144	Wrench Adapter
51149	Angulation Gauge, SP
90138	Adjustment Handle
41214	X-ray Planner ProActive Edge Implants
41119	X-ray Planner ProActive Straight Implants
41183	X-ray Planner ProActive Tapered Implants
41203	X-ray Planner Ø6.0 Implants
41200	X-ray Planner Ø6.5 Implants

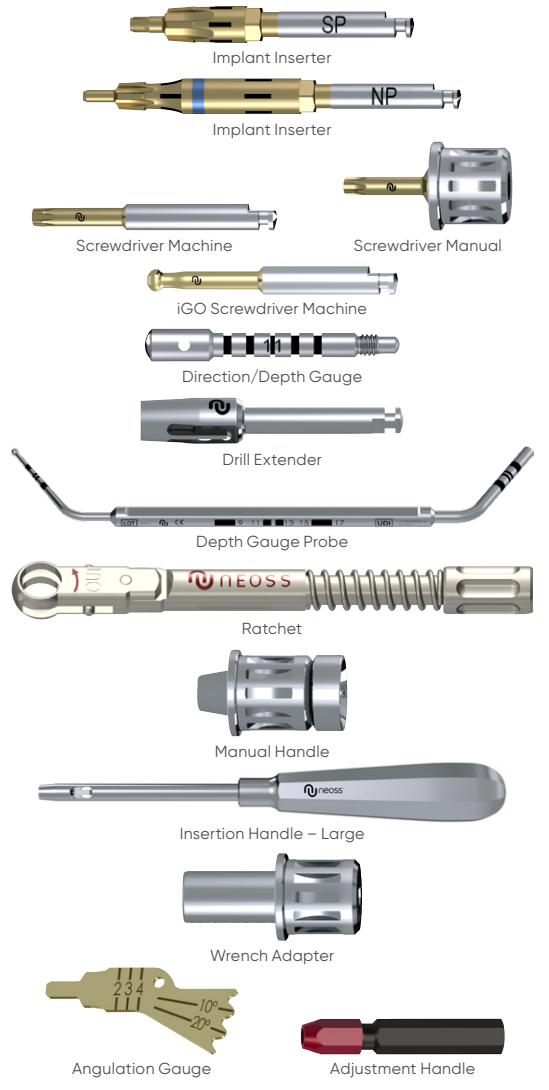

Prosthetic Solution Standard and Narrow Platform, overview

Overview Prosthetic Solutions, SP and NP (Ø3.25 – 6.5 Implants)



		Units		Retention		Implant platform		Level			Material					Angulated screw channel	Esthetiline		
		Mono	Multi	Cement retained	Screw retained	SP	NP	Implant level	Access level	Multi-Unit Abutment level	Ti	ZrO	Gold	CoCr	Polymer				
Provisional Restorations	Provisional Ti Abutment	☑	☑	☑	☑	☑	☑	☑	☑	☑	☑								
	Esthetic Tissue Former	☑		☑	☑	☑		☑						☑			☑		
	Healing Cap									☑									
Final Restorations	Prefabricated	Prepable Ti Abutment	☑		☑	☑	☑	☑				☑						☑	
		Zirconia Abutment	☑		☑	☑	☑		☑				☑					☑	
		Access Abutment (0 – 30°)		☑		☑	☑		☑				☑						
		Multi-Unit Abutment		☑		☑	☑		☑				☑						
	Digital	NeoBase® (SSC, ASC*)	☑	☑	☑	☑	☑	☑	☑		☑	☑						☑	☑
		TiBase**	☑		☑	☑	☑	☑	☑			☑							
		Ti NeoLink®	☑	☑	☑	☑	☑	☑	☑	☑		☑							☑
		Blanks	☑	☑	☑	☑	☑	☑	☑			☑			☑				☑
	Casting	Individual Prosthetics* central milling	☑	☑	☑	☑	☑	☑	☑	☑	☑	☑	☑		☑		☑	☑	☑
		Gold NeoLink®	☑	☑		☑	☑	☑	☑	☑				☑					☑
Burnout Abutment		☑	☑	☑	☑	☑	☑	☑	☑										
Overdenture	CoCr Abutment	☑	☑	☑	☑	☑		☑						☑					
	Equator Abutment		☑			☑	☑	☑	☑										
	Bar Abutment		☑			☑		☑											

* Utilise iGO Abutment Screw and Screwdriver for angulated screw channels, optional for straight screw channels on Individual Prosthetics milled by Neoss
 ** Compatible with Dentsply Sirona*

Torque and Speed recommendation, overview

Neoss Implant System Torque Recommendation (Ncm)

Implants	Screw Taps	Healing			Provisional		Impression	Final restoration				
		Cover Screw	Healing Abutment PEEK and Esthetic Healing Abutment	Healing Abutment Ti	Esthetic Tissue Former	Provisional Ti Abutment		Impression Coping Screw	Neo Abutment Screw	Multi-Unit and Access Abutment Straight & Angulated	Multi-Unit and Neo Access Prosthetic Screw	Equator Abutment
45 Max	40 – 45	10 Max	10 Max	10 Max	20	20	10 Max	32*	32	20	32	20
											Implant level	Access level
											32	20

* 35 Ncm optional for high-load cases

Final restoration with iGO Screws		
iGO Abutment Screw, SP	iGO Abutment Screw, NP	iGO Prosthetic Screw, Access
32	20	20

Neoss Implant System Drilling/Insertion Speed Recommendation (rpm)

Drills	Screw Taps	Countersinks	Implants	Bone Mill
800 – 2000**	20	800	20 Max	40 Max

** lower speed for larger drills

Symbols, names and abbreviations



SP = Standard Platform Ø3.5 – 6.5 Implants

NP = Narrow Platform Ø3.25 Implants

iGO = utilises iGO Screw and Screwdriver

Neo = Neoss standard Screw/Screwdriver

SSC = Straight Screw Channel

ASC = Angulated Screw Channel

You can now buy your products online!

Products can also be ordered online at neoss.com.

Some products may not be regulatory or commercially available for all markets and available in limited quantities. Contact your local representative for availability and prices.

Disclaimer of Liability

Neoss products may only be used according to the manufacturers' instructions and recommendations.

The user of Neoss products should determine their suitability for particular patients and indications.

Neoss Limited disclaims any liability, expressed or implied, and shall have no responsibility for any direct, indirect, punitive or other damages arising out of or in connection with any errors in professional judgment or practice in the use or placement of the Neoss products.

Product images are not to scale and are subject to change.

All dimensions are for identification purposes only.

Copyrights, design rights and trademarks:

Neoss documents, software and designs may not be reprinted, copied or published in whole or part, without the written authorisation of Neoss Limited.

Neoss, 'N' logo, NeoGen, NeoLink, NeoLoc, NeoBase and Neoss ProActive are registered trademarks of Neoss Group. NeoScan is a trademark of Neoss Group.

THE Graft™ is a trademark of Purgo Biologics Inc. Biotex® is a registered trademark by Purgo Biologics Inc.

Elos Accurate is a registered trademark of Elos Medtech AB. LOCATOR® is a registered trademarks of ZEST IP Holdings, LLC U.S.



Do you want to *lower your inventory costs* and minimize confusion?

NeossONE® is a solution unique to the Neoss implant system – one prosthetic platform, across three implant designs. Simply put, the same prosthetic components fit every implant. The benefits are clear: reducing patient treatment time, optimizing inventory control and minimized product confusion.

- ✓ Reduce steps, saves time
- ✓ Less inventory and maximum flexibility
- ✓ Minimize confusion and mistakes
- ✓ Cost-effective solution for all



NeossONE®



Order your products
24/7 in our Online Store
at shop-au.neoss.com
and neoss-nz.myshopify.com



For our Terms & Conditions consult your local website on www.neoss.com

Contact your local representative for product availability details.
All products are not available in every market.

AUSTRALIA & NEW ZEALAND

Neoss Australia Pty. Ltd

G04 Ground Floor North Tower, John Oxley Centre,
339 Coronation Drive, Milton Qld 4064, Australia

T: +61 7 3216 0165

E: info.au@neoss.com

10622_25 AUS_NZ 2023-08 © Neoss Limited, 2023. Copyrights, design rights and trademarks, Neoss documents, software and designs may not be reprinted, copied or published in whole or part, without the written authorisation of Neoss Limited.