



Product Catalog

2023 | 2024

Intelligent Simplicity

Explore

Intelligent Simplicity

Neoss offers intelligent solutions that are intuitively easy to use. Our products allow dental professionals to provide reliable and cost-effective treatments to their patients with predictable long-term results. With ingenuity and ambition, we strive to set new standards, leading the market with integrity. In developing smart treatment solutions and working closely with our customers, Neoss makes the complex less complicated. We call that Intelligent Simplicity.



Implants	4	Neoss ProActive® Edge Implants	
	6	Neoss ProActive® Tapered Implants Neoss ProActive® Wide Implants Neoss ProActive® Sinus Implants	
	7	Neoss ProActive® Straight Implants	
	8	Neoss ProActive® Straight NP Ø3.25 Implants Cover Screw	
	9	Bone Xenograft NeoGenix XP in jar NeoGenix XP in syringes Bone Allograft Mineralized Cortical/Cancellous Particulate Mineralized Cortical Particulate	
Biomaterials	10	Resorbable Membranes Collagen Membranes Wound Dressings Non-Resorbable Membranes Ti-reinforced PTFE Membranes NeoGen® Cape	
	11	Non-reinforced PTFE Membranes Fixation Kit Sutures	
	Digital	12	Resonance Frequency Device (RFA) NeoTell™ NEW Intraoral Scanners NeoScan™ 1000 NeoScan™ 2000 NEW
		13	Digital Impression Esthetic Healing Abutments with ScanPeg ScanPeg Scan Bodies Analogs
		14	Digital Prosthetics NeoBase® Abutments SSC (Straight Screw Channel) NeoBase® Abutments ASC (Angulated Screw Channel) Neoss TiBase Abutments (compatible with Dentsply Sirona®) Ti NeoLink®
	Prosthetics	15	16 Neoss4+ treatment solution Multi-Unit Abutments NEW
		17	Access Abutments Multi-Unit/Access Screws
		18	Healing Abutments Esthetic Healing Abutments with ScanPeg Healing Abutments Provisional Abutments Esthetic Tissue Formers
		19	Provisional Titanium Abutments Final Abutments Prepable Titanium Abutments Prepable Titanium Abutments, Alternative Emergence Profiles
		20	Zirconia Abutments Final Restorations – Casting Gold NeoLink® (Direct Casting) CoCr Abutments (Indirect Casting) Burnout Abutments (Direct Casting)
21		Overdenture Abutments Equator Abutments Bar Abutment	
22		Overdenture LOCATOR® Solution Impressions & Replicas Impressions Copings	
23		Replicas Screws	
Instruments & More		24	Drills
		26	Kits Surgical & Prosthetic Trays Surgical & Prosthetic Kits with instruments and drills
	27	Guide Neoss® Guide Kit – SPARE PARTS Demo Kit	
Support	28	Instruments	
	29	Prosthetic Solution Standard and Narrow Platform, overview Torque and Speed recommendation, overview	
	30	Symbols, names and abbreviations You can now buy your products online! Disclaimer of Liability	

Neoss ProActive® implants – *Proven predictability* in implant treatment since 2002

All implants produced of highest quality, Commercially Pure Titanium Grade 4.

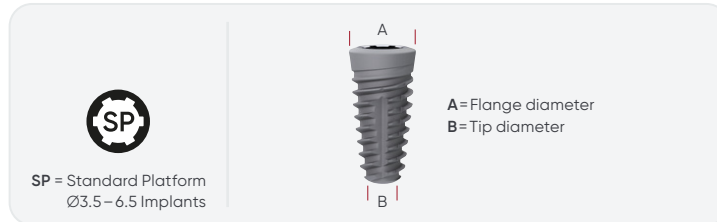
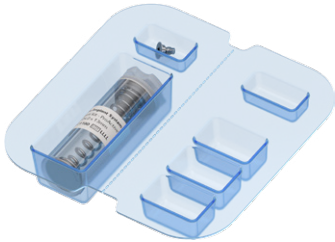

Neoss Implant

The Implant includes Implant and Cover Screw.



Neoss ProActive® Edge Implants

Art. No.	Description	A	B
21417	Implant – Neoss ProActive® Edge Ø3.5×9 mm		
21418	Implant – Neoss ProActive® Edge Ø3.5×11 mm		
21419	Implant – Neoss ProActive® Edge Ø3.5×13 mm	4.0 mm	1.6 mm
21420	Implant – Neoss ProActive® Edge Ø3.5×15 mm		
21421	Implant – Neoss ProActive® Edge Ø3.5×17 mm		
21423	Implant – Neoss ProActive® Edge Ø4.0×9 mm		
21424	Implant – Neoss ProActive® Edge Ø4.0×11 mm		
21425	Implant – Neoss ProActive® Edge Ø4.0×13 mm	4.3 mm	1.9 mm
21426	Implant – Neoss ProActive® Edge Ø4.0×15 mm		
21427	Implant – Neoss ProActive® Edge Ø4.0×17 mm		
21429	Implant – Neoss ProActive® Edge Ø4.5×9 mm		
21430	Implant – Neoss ProActive® Edge Ø4.5×11 mm		
21431	Implant – Neoss ProActive® Edge Ø4.5×13 mm	4.9 mm	2.2 mm
21432	Implant – Neoss ProActive® Edge Ø4.5×15 mm		
21433	Implant – Neoss ProActive® Edge Ø4.5×17 mm		
21435	Implant – Neoss ProActive® Edge Ø5.0×9 mm		
21436	Implant – Neoss ProActive® Edge Ø5.0×11 mm		
21437	Implant – Neoss ProActive® Edge Ø5.0×13 mm	5.4 mm	2.4 mm
21438	Implant – Neoss ProActive® Edge Ø5.0×15 mm		
21439	Implant – Neoss ProActive® Edge Ø5.0×17 mm		



SP = Standard Platform
Ø3.5–6.5 Implants



A = Flange diameter
B = Tip diameter



Implant kits Ø3.5–4.5

Implant kits Ø5.0

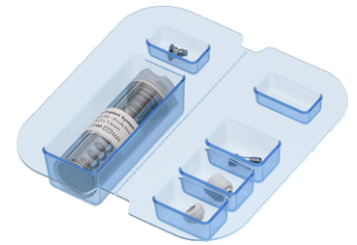

Neoss Implant Kit

The Implant Kit includes Implant, Cover Screw, Healing Abutments in PEEK in two different sizes and Healing Abutment Screw.

Neoss ProActive® Edge Implants

Art. No.	Description	A	B
21301	Implant Kit – Neoss ProActive® Edge Ø3.5×9mm		
21302	Implant Kit – Neoss ProActive® Edge Ø3.5×11mm	4.0mm	1.6mm
21303	Implant Kit – Neoss ProActive® Edge Ø3.5×13mm		
21304	Implant Kit – Neoss ProActive® Edge Ø3.5×15mm		
21305	Implant Kit – Neoss ProActive® Edge Ø4.0×9mm		
21306	Implant Kit – Neoss ProActive® Edge Ø4.0×11mm	4.3mm	1.9mm
21307	Implant Kit – Neoss ProActive® Edge Ø4.0×13mm		
21308	Implant Kit – Neoss ProActive® Edge Ø4.0×15mm		
21309	Implant Kit – Neoss ProActive® Edge Ø4.5×9mm		
21310	Implant Kit – Neoss ProActive® Edge Ø4.5×11mm	4.9mm	2.2mm
21311	Implant Kit – Neoss ProActive® Edge Ø4.5×13mm		
21312	Implant Kit – Neoss ProActive® Edge Ø4.5×15mm		
21313	Implant Kit – Neoss ProActive® Edge Ø5.0×9mm		
21314	Implant Kit – Neoss ProActive® Edge Ø5.0×11mm	5.4mm	2.4mm
21315	Implant Kit – Neoss ProActive® Edge Ø5.0×13mm		
21316	Implant Kit – Neoss ProActive® Edge Ø5.0×15mm		



ProActive Edge Ø3.5



ProActive Edge Ø4.0



ProActive Edge Ø4.5



ProActive Edge Ø5.0

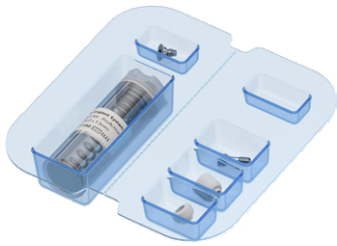

Neoss Implant Kit

The Implant Kit includes Implant, Cover Screw, Healing Abutments (Ø5.0 – 5.5 implant kits include a wider version) in PEEK in two different sizes and Healing Abutment Screw.



Neoss ProActive® Tapered Implants

Art. No.	Description	A	B
21221	Implant Kit – Neoss ProActive® Tapered Ø3.5×9mm		
21222	Implant Kit – Neoss ProActive® Tapered Ø3.5×11mm	4.0mm	2.1mm
21223	Implant Kit – Neoss ProActive® Tapered Ø3.5×13mm		
21224	Implant Kit – Neoss ProActive® Tapered Ø3.5×15mm		
21227	Implant Kit – Neoss ProActive® Tapered Ø4.0×9mm		
21228	Implant Kit – Neoss ProActive® Tapered Ø4.0×11mm	4.3mm	2.3mm
21229	Implant Kit – Neoss ProActive® Tapered Ø4.0×13mm		
21230	Implant Kit – Neoss ProActive® Tapered Ø4.0×15mm		
21233	Implant Kit – Neoss ProActive® Tapered Ø4.5×9mm		
21234	Implant Kit – Neoss ProActive® Tapered Ø4.5×11mm	4.9mm	2.8mm
21235	Implant Kit – Neoss ProActive® Tapered Ø4.5×13mm		
21236	Implant Kit – Neoss ProActive® Tapered Ø4.5×15mm		
21239	Implant Kit – Neoss ProActive® Tapered Ø5.0×9mm		
21240	Implant Kit – Neoss ProActive® Tapered Ø5.0×11mm	5.4mm	3.3mm
21241	Implant Kit – Neoss ProActive® Tapered Ø5.0×13mm		
21242	Implant Kit – Neoss ProActive® Tapered Ø5.0×15mm		
21245	Implant Kit – Neoss ProActive® Tapered Ø5.5×9mm		
21246	Implant Kit – Neoss ProActive® Tapered Ø5.5×11mm	5.9mm	3.8mm
21247	Implant Kit – Neoss ProActive® Tapered Ø5.5×13mm		

Neoss ProActive® Wide Implants

Art. No.	Description	A	B
21252	Implant Kit – Neoss ProActive® Ø6.0×7mm		4.5mm
21250	Implant Kit – Neoss ProActive® Ø6.0×9mm	6.0mm	4.3mm
21251	Implant Kit – Neoss ProActive® Ø6.0×11mm		4.3mm

Neoss ProActive® Sinus Implants

Art. No.	Description	A
21211	Implant Kit – Neoss ProActive® Ø6.5×7mm	
21212	Implant Kit – Neoss ProActive® Ø6.5×9mm	6.7mm
21213	Implant Kit – Neoss ProActive® Ø6.5×11mm	



SP = Standard Platform
Ø3.5–6.5 Implants



A = Flange diameter
B = Tip diameter

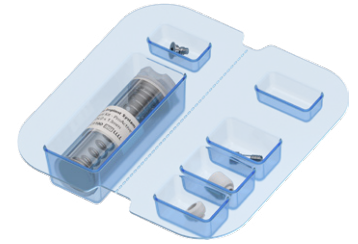
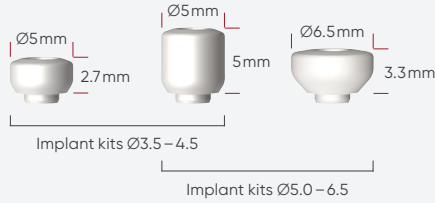

Neoss Implant Kit

The Implant Kit includes Implant, Cover Screw, Healing Abutments (Ø5.0–6.5 implant kits include a wider version) in PEEK in two different sizes and Healing Abutment Screw.

Neoss ProActive® Straight Implants

Art. No.	Description	A	B
21181	Implant Kit – Neoss ProActive® Straight Ø3.5×7 mm		
21182	Implant Kit – Neoss ProActive® Straight Ø3.5×9 mm		
21183	Implant Kit – Neoss ProActive® Straight Ø3.5×11 mm	4.0 mm	2.4 mm
21184	Implant Kit – Neoss ProActive® Straight Ø3.5×13 mm		
21185	Implant Kit – Neoss ProActive® Straight Ø3.5×15 mm		
21186	Implant Kit – Neoss ProActive® Straight Ø3.5×17 mm		
21187	Implant Kit – Neoss ProActive® Straight Ø4.0×7 mm		
21188	Implant Kit – Neoss ProActive® Straight Ø4.0×9 mm		
21189	Implant Kit – Neoss ProActive® Straight Ø4.0×11 mm	4.0 mm	2.8 mm
21190	Implant Kit – Neoss ProActive® Straight Ø4.0×13 mm		
21191	Implant Kit – Neoss ProActive® Straight Ø4.0×15 mm		
21192	Implant Kit – Neoss ProActive® Straight Ø4.0×17 mm		
21193	Implant Kit – Neoss ProActive® Straight Ø4.5×7 mm		
21194	Implant Kit – Neoss ProActive® Straight Ø4.5×9 mm		
21195	Implant Kit – Neoss ProActive® Straight Ø4.5×11 mm	4.5 mm	3.2 mm
21196	Implant Kit – Neoss ProActive® Straight Ø4.5×13 mm		
21197	Implant Kit – Neoss ProActive® Straight Ø4.5×15 mm		
21198	Implant Kit – Neoss ProActive® Straight Ø4.5×17 mm		
21199	Implant Kit – Neoss ProActive® Straight Ø5.0×7 mm		
21200	Implant Kit – Neoss ProActive® Straight Ø5.0×9 mm		
21201	Implant Kit – Neoss ProActive® Straight Ø5.0×11 mm	5.0 mm	3.7 mm
21202	Implant Kit – Neoss ProActive® Straight Ø5.0×13 mm		
21203	Implant Kit – Neoss ProActive® Straight Ø5.0×15 mm		
21205	Implant Kit – Neoss ProActive® Straight Ø5.5×7 mm		
21206	Implant Kit – Neoss ProActive® Straight Ø5.5×9 mm		
21207	Implant Kit – Neoss ProActive® Straight Ø5.5×11 mm	5.5 mm	4.2 mm
21208	Implant Kit – Neoss ProActive® Straight Ø5.5×13 mm		



ProActive Straight Ø3.5



ProActive Straight Ø4.0



ProActive Straight Ø4.5



ProActive Straight Ø5.0



ProActive Straight Ø5.5

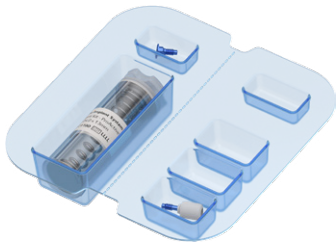

Neoss Implant Kit

The Neoss ProActive® NP Ø3.25 implant kit includes Implant, Cover Screw, Healing Abutment and Healing Abutment Screw.

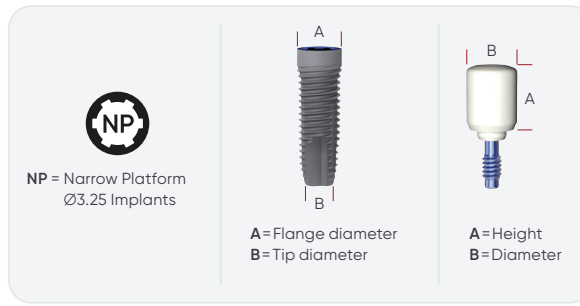

ProActive Straight NP Ø3.25

Neoss ProActive® Straight NP Ø3.25 Implants

Art. No.	Description	A	B
21176	Implant Kit – Neoss ProActive® Straight, NP Ø3.25×9mm		
21177	Implant Kit – Neoss ProActive® Straight, NP Ø3.25×11mm	3.5mm	2.2mm
21178	Implant Kit – Neoss ProActive® Straight, NP Ø3.25×13mm		
21179	Implant Kit – Neoss ProActive® Straight, NP Ø3.25×15mm		



Cover Screw

Cover Screw

Art. No.	Description
31408	Cover Screw SP
31409	Cover Screw NP

Solutions for your guided bone *regeneration* procedures

Bone Xenograft

NeoGenix XP in jar

Art. No.	Description	Weight	Volume
64091	NeoGenix XP 0.5cc (0.25 – 1 mm particle size) Jar	0.15g	0.5cc
64092	NeoGenix XP 1.0 cc (0.25 – 1 mm particle size) Jar	0.25g	1.0 cc
64093	NeoGenix XP 2.0cc (0.25 – 1 mm particle size) Jar	0.50g	2.0cc
64094	NeoGenix XP 4.0cc (0.25 – 1 mm particle size) Jar	1.00g	4.0cc
64095	NeoGenix XP 1.0cc (1 – 2 mm particle size) Jar	2.00g	1.0 cc
64096	NeoGenix XP 2.0cc (1 – 2 mm particle size) Jar	0.50g	2.0cc



NeoGenix XP in jar

NeoGenix XP in syringes

Art. No.	Description	Weight	Volume
64097	NeoGenix XP 0.25 cc (0.25 – 1 mm particle size) Curved Syringe	0.10g	0.25cc
64098	NeoGenix XP 0.5cc (0.25 – 1 mm particle size) Curved Syringe	0.21g	0.5cc



NeoGenix XP in syringes

Bone Allograft

Mineralized Cortical/Cancellous Particulate

Art. No.	Description
64063	NeoGen® Allograft Mineralized Cortical Cancellous Particulate 250-1000µm 0.25cc-U
64064	NeoGen® Allograft Mineralized Cortical Cancellous Particulate 250-1000µm 0.5cc-U
64065	NeoGen® Allograft Mineralized Cortical Cancellous Particulate 250-1000µm 1.0cc-U
64066	NeoGen® Allograft Mineralized Cortical Cancellous Particulate 250-1000µm 2.0cc-U
64067	NeoGen® Allograft Mineralized Cortical Cancellous Particulate 250-1000µm 2.5cc-U
64068	NeoGen® Allograft Mineralized Cortical Cancellous Particulate 250-1000µm 5.0cc-U



NeoGen® Allograft Mineralized

Mineralized Cortical Particulate

Art. No.	Description
64069	NeoGen® Allograft Mineralized Cortical Particulate 250-1000µm 0.25cc-U
64070	NeoGen® Allograft Mineralized Cortical Particulate 250-1000µm 0.5cc-U
64071	NeoGen® Allograft Mineralized Cortical Particulate 250-1000µm 1.0cc-U
64072	NeoGen® Allograft Mineralized Cortical Particulate 250-1000µm 2.0cc-U
64073	NeoGen® Allograft Mineralized Cortical Particulate 250-1000µm 2.5cc-U
64074	NeoGen® Allograft Mineralized Cortical Particulate 250-1000µm 5.0cc-U



NeoGen® Allograft Mineralized

Resorbable Membranes

Collagen Membranes

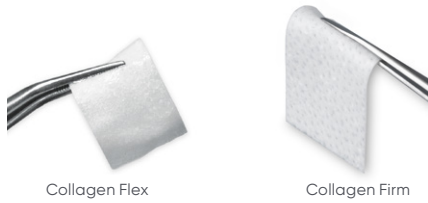

Collagen Flex

Collagen Firm

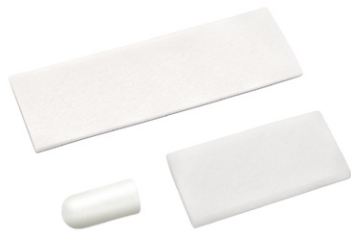

Wound Dressings

Art. No.	Description	A	B
64050	NeoGen® Collagen Membrane Flex S	20mm	15mm
64051	NeoGen® Collagen Membrane Flex M	30mm	20mm
64052	NeoGen® Collagen Membrane Flex L <i>NeoGen® Collagen Flex resorbs in 3–4 months</i>	40mm	30mm
64055	NeoGen® Collagen Membrane Firm S	20mm	15mm
64056	NeoGen® Collagen Membrane Firm M	30mm	20mm
64057	NeoGen® Collagen Membrane Firm L <i>NeoGen® Collagen Firm resorbs in 6–9 months</i>	40mm	30mm

Wound Dressings

Art. No.	Description	A	B
64060	NeoGen® Collagen Wound Dressing Tape (1 mm thick, 10 pcs)	75mm	25mm
64061	NeoGen® Collagen Wound Dressing Foam (4 mm thick, 10 pcs)	40mm	20mm
64062	NeoGen® Collagen Wound Dressing Plug (10 pcs)	20mm	10mm

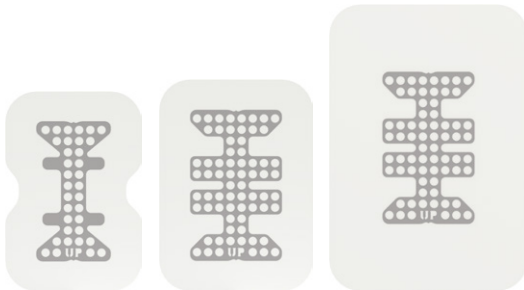
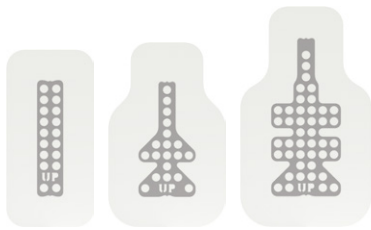
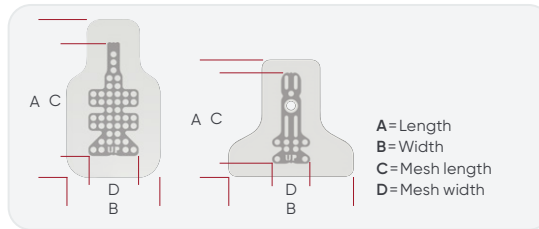

Ti-Reinforced Membranes

Non-Resorbable Membranes

Ti-reinforced PTFE Membranes

Art. No.	Description	A	B	C	D
64010	NeoGen® PTFE Membrane, Ti-Reinforced – S I <i>(Small Interproximal)</i>	29mm	14mm	19mm	4mm
64011	NeoGen® PTFE Membrane, Ti-Reinforced – M I <i>(Medium Interproximal)</i>	30mm	19mm	19mm	9mm
64012	NeoGen® PTFE Membrane, Ti-Reinforced – L I <i>(Large Interproximal)</i>	36mm	21mm	26mm	11mm
64013	NeoGen® PTFE Membrane, Ti-Reinforced – M <i>(Medium)</i>	32mm	22mm	23mm	12mm
64014	NeoGen® PTFE Membrane, Ti-Reinforced – L <i>(Large)</i>	34mm	25mm	24mm	15mm
64015	NeoGen® PTFE Membrane, Ti-Reinforced – XL <i>(Extra Large)</i>	46mm	32mm	24mm	15mm

NeoGen® Cape

All NeoGen® Cape Spacer include a NeoGen® Cape Screw



NeoGen® Cape



NeoGen® Cape Spacer



NeoGen® Cape Screw

Art. No.	Description	A	B	C	D
64040	NeoGen® Cape PTFE Membrane – M	28mm	30mm	16mm	9mm
64041	NeoGen® Cape PTFE Membrane – L	28mm	30mm	22mm	9mm
64080	NeoGen® Cape Spacer 0.7mm, Neoss SP				
64081	NeoGen® Cape Spacer 1.5mm, Neoss SP				
64082	NeoGen® Cape Spacer 0.7mm, Neoss NP				
64083	NeoGen® Cape Spacer 1.5mm, Neoss NP				

Non-reinforced PTFE Membranes

Art. No.	Description	A	B
64019	NeoGen® PTFE Membrane, Non-Reinforced	18 mm	12 mm
64020	NeoGen® PTFE Membrane, Non-Reinforced	29 mm	14 mm
64021	NeoGen® PTFE Membrane, Non-Reinforced	34 mm	25 mm



Non-Reinforced Membranes

Fixation Kit

Art. No.	Description
64031	Tack Positioning Instrument
64033	Tack Mallet
64034	Tack and Screw Cassette
64036	Membrane Tack 3 mm – 10 pcs
64037	Membrane Screw 3 mm – 10 pcs



Tack Positioning Instrument



Tack Mallet



Tack and Screw Cassette



Membrane Tack



Membrane Screw

Sutures

Art. No.	Description
32.Z4401.00	Neoss PTFE Suture 60 cm 4/0 – Reverse Cutting 16 mm 3/8 (12 pcs)
32.Z4408.00	Neoss PTFE Suture 60 cm 6/0 – Reverse Cutting 12 mm 3/8 (12 pcs)



PTFE Suture

The *measurement of implant stability* begins with NeoTell™

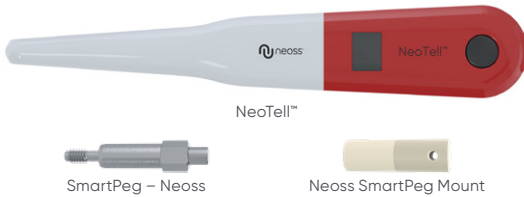

Resonance Frequency Device (RFA)

NeoTell™ **NEW**

Art. No. Description

91060	NeoTell™ Instrument <i>Includes NeoTell™ Instrument, SmartPeg Mount, TestPeg and USB cable, type A-C</i>
91070	SmartPeg Type 18 – Neoss SP
91071	SmartPeg Type 38 – Neoss NP
91072	SmartPeg Type 52 – Neoss Access Abutment
91075	Neoss SmartPeg Mount

SmartPegs for other brands are available, contact your local representative for details

New opportunities for your *EasyDigital* workflow



NeoScan

Intraoral Scanners

NeoScan™ 1000

Art. No. Description

91000	NeoScan™ 1000 Intraoral Scanner <i>Includes Handpiece, 4 tips (2×S, 2×L), Holder Set, Manuals, Suitcase. Extended warranties are available for purchase</i>
91012	NeoScan™ 1000 – Tip L TP102N (2 pcs)
91013	NeoScan™ 1000 – Tip S TP103N (2 pcs)
91022	Trolley for Intraoral Scanner
91024	NeoScan™ 1000 – Warranty extension – 1 year
91026	NeoScan™ 1000 – Warranty extension – 2 years
91027	NeoScan™ 1000 – Warranty extension – 3 years



NeoScan™ 2000

NeoScan™ 2000 **NEW**

Art. No. Description

91001	NeoScan™ 2000 Intraoral Scanner <i>Includes Handpiece, 4 tips (2×S, 2×L), Charging holder, 2 batteries, Stand, Manuals, Wi-Fi adaptor, Suitcase. Extended warranties are available for purchase</i>
91014	NeoScan™ 2000 – Tip L TP102N (2 pcs)
91015	NeoScan™ 2000 – Tip S TP103N (2 pcs)
91040	NeoScan™ 2000 – Battery (2 pcs)
91032	NeoScan™ 2000 – Warranty extension – 1 year
91033	NeoScan™ 2000 – Warranty extension – 2 years
91034	NeoScan™ 2000 – Warranty extension – 3 years

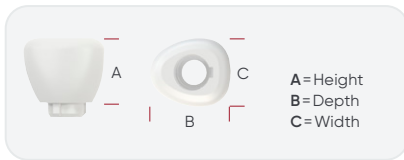

Digital Impression

Esthetic Healing Abutments with ScanPeg

All Esthetic Healing Abutments include Titanium Screw and a ScanPeg

Art. No.	Description	A	B	C
31360	Esthetic Healing Abutment with ScanPeg – Wide Incisor	5mm	5.7mm	6.1mm
31361	Esthetic Healing Abutment with ScanPeg – Narrow Incisor		5.2mm	5mm
31362	Esthetic Healing Abutment with ScanPeg – Canine		6.3mm	5.4mm
31363	Esthetic Healing Abutment with ScanPeg – Pre-molar		6.8mm	5.8mm
31364	Esthetic Healing Abutment with ScanPeg – Molar		7.8mm	7.3mm



Esthetic Healing Abutment with ScanPeg



Esthetic Healing Abutments

ScanPeg

Art. No. Description

Esthetic Healing Abutments with ScanPeg can also be utilised for digital impressions

31365	ScanPeg – 5 pcs Used only with Esthetic Healing Abutments
-------	--



ScanPeg

Scan Bodies

Art. No. Description

90181	Scan Body Neoss® SP (IO 1A-A)
90182	Scan Body Neoss® NP (IO 1A-B)
90183	Scan Body Neoss® Access (IO 1B-A)
31450	Multi-Unit Scan Body

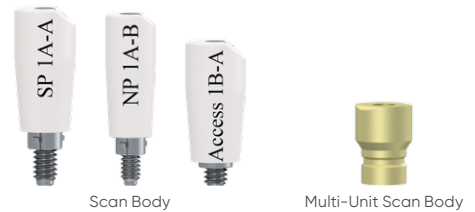

Scan Body

Multi-Unit Scan Body

Analogs

Art. No. Description

90190	Analog for Printed Model Neoss® SP
90191	Analog for Printed Model Neoss® NP
90192	Analog for Printed Model Neoss® Access
91074	Analog for Printed Model Neoss® Multi-Unit
PMA-AIT-1	Elos Accurate® Analog Pliers
PMA-AIP-2	Elos Accurate® Analog Insertion Pin (2 pcs)
PMA-AIS-5	Elos Accurate® Analog Insertion Screw (5 pcs)



Analogs for Printed Model



Analog Pliers



Analog Insertion Pin



Analog Insertion Screw

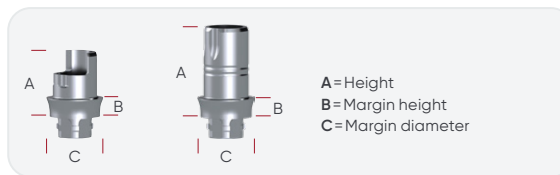

Digital Prosthetics

NeoBase® Abutments SSC (Straight Screw Channel)*



also referred to as TiBase

All NeoBase® Abutments SSC include Neo Abutment Screw and Neo Laboratory Screw



Art. No.	Description	A	B	C
31393	NeoBase® Mono SSC G0.3mm – H3.6mm	3.9mm	0.3mm	
31394	NeoBase® Mono SSC G1.5mm – H3.6mm	5.1mm	1.5mm	
31395	NeoBase® Mono SSC G0.3mm – H5.6mm	5.9mm	0.3mm	4.5mm
31396	NeoBase® Mono SSC G1.5mm – H5.6mm	7.1mm	1.5mm	
31397	NeoBase® Multi SSC G0.3mm – H3.6mm	3.9mm	0.3mm	
31398	NeoBase® Mono SSC G0.3mm – H3.6mm, NP	3.9mm		
31399	NeoBase® Mono SSC G0.3mm – H5.6mm, NP	5.9mm	0.3mm	3.8mm
31400	NeoBase® Multi SSC G0.3mm – H3.6mm, NP	3.9mm		

Include Neo Abutment Screw NP and Neo Laboratory Screw NP

NeoBase® Abutments ASC (Angulated Screw Channel)*



also referred to as TiBase

All NeoBase® Abutments ASC include iGO Abutment Screw and iGO Laboratory Screw



Art. No.	Description	A	B	C
31367	NeoBase® Mono ASC G0.3mm – H3.6mm	3.9mm	0.3mm	
31368	NeoBase® Mono ASC G1.5mm – H3.6mm	5.1mm	1.5mm	
31369	NeoBase® Mono ASC G0.3mm – H5.6mm	5.9mm	0.3mm	4.5mm
31370	NeoBase® Mono ASC G1.5mm – H5.6mm	7.1mm	1.5mm	
31371	NeoBase® Multi ASC G0.3mm – H3.6mm	3.9mm	0.3mm	
31372	NeoBase® Mono ASC G0.3mm – H3.6mm, NP	3.9mm		
31373	NeoBase® Mono ASC G0.3mm – H5.6mm, NP	5.9mm	0.3mm	3.8mm
31374	NeoBase® Multi ASC G0.3mm – H3.6mm, NP	3.9mm		

Include iGO Abutment Screw NP and iGO Laboratory Screw NP

Neoss TiBase Abutments (compatible with Dentsply Sirona®)

All TiBase Abutments include Neo Abutment Screw and Titanium Screw



Art. No.	Description	A	B	C
31329	Neoss TiBase N (NB B 3.4 L)	5.3mm	0.6mm	4.5mm
31330	Neoss TiBase W (NB B 4.1 L)			5.0mm
31345	Neoss TiBase, NP (FX 3.4 S)	5mm	0.3mm	3.9mm
31331	Neoss ScanPost L (TiBase) Includes ScanPost with Screw			
31346	Neoss ScanPost S (TiBase, NP) Includes ScanPost with Screw NP			

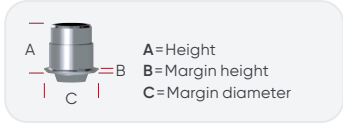

Ti NeoLink®

Titanium NeoLinks include Neo Abutment Screw, Neo Laboratory Screw and Straight Copings

Art. No.	Description	A	B	C
31133	Ti NeoLink® Mono	3.9mm	0.3mm	4.5mm
31134	Ti NeoLink® Multi			
31234	Ti NeoLink® Mono, NP <i>Includes Neo Abutment Screw Ti NP, Neo Laboratory Screw NP and a set of Preformed Plastic Copings</i>			3.8mm



Experience *easy-to-use full arch flexibility* with predictable results using Neoss4+ treatment solution

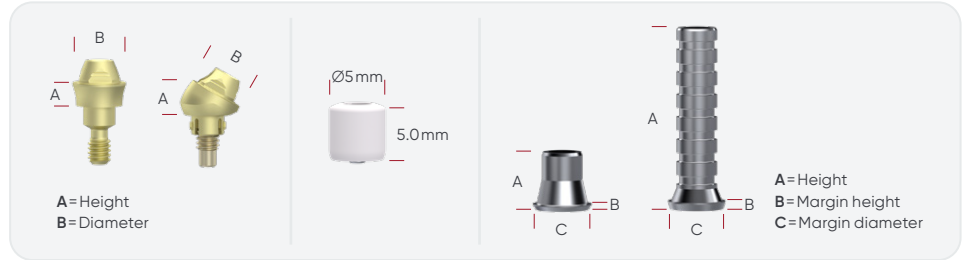

Neoss4+ treatment solution

Multi-Unit Abutments **NEW**

Clinical screw fixed within the Multi-Unit Abutment
Healing Cap and Replica needs to be ordered seperately

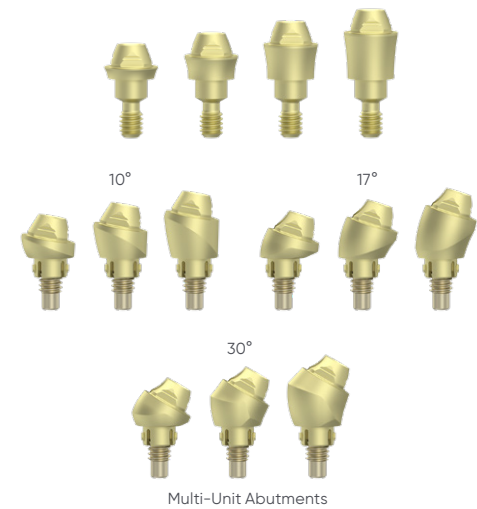

Multi-Unit Abutments



Multi-Unit Healing Cap



Multi-Unit Impression Coping Open tray



Multi-Unit Impression Coping Closed tray



Multi-Unit Replica



Multi-Unit NeoBase® SSC



Multi-Unit Provisional Abutment Ti



Multi-Unit NeoBase® ASC



Multi-Unit Scan Body



Analog for Printed Model Neoss® Multi-Unit

Art. No.	Description	A	B	C
31411	Multi-Unit Abutment 1.0 mm	1 mm	4.6 mm	
31412	Multi-Unit Abutment 2.0 mm	2 mm		
31413	Multi-Unit Abutment 3.0 mm	3 mm		
31414	Multi-Unit Abutment 4.0 mm	4 mm		
31425	Multi-Unit Abutment 10° 2.0 mm	2 mm	4.6 mm	
31426	Multi-Unit Abutment 10° 3.0 mm	3 mm		
31427	Multi-Unit Abutment 10° 4.0 mm	4 mm		
31429	Multi-Unit Abutment 17° 2.5 mm	2.5 mm	4.6 mm	
31430	Multi-Unit Abutment 17° 3.5 mm	3.5 mm		
31431	Multi-Unit Abutment 17° 4.5 mm	4.5 mm		
31433	Multi-Unit Abutment 30° 3.0 mm	3 mm	4.6 mm	
31434	Multi-Unit Abutment 30° 4.0 mm	4 mm		
31435	Multi-Unit Abutment 30° 5.0 mm	5 mm		
31440	Multi-Unit Healing Cap	5 mm	5 mm	
31442	Multi-Unit Impression Coping Open tray 6 mm*			
31443	Multi-Unit Impression Coping Closed tray 10 mm*			
31444	Multi-Unit Replica – 5 pcs			
31445	Multi-Unit Provisional Abutment Ti	15.7 mm	0.7 mm	5 mm
31446	Multi-Unit NeoBase® SSC G 0.5 mm – H 4.5 mm	5 mm	0.5 mm	5.1 mm
31447	Multi-Unit NeoBase® ASC G 0.5 mm – H 4.5 mm iGO	5 mm	0.5 mm	5.1 mm
31450	Multi-Unit Scan Body			
91074	Analog for Printed Model Neoss® Multi-Unit			

*Not co-packed and should be ordered separately

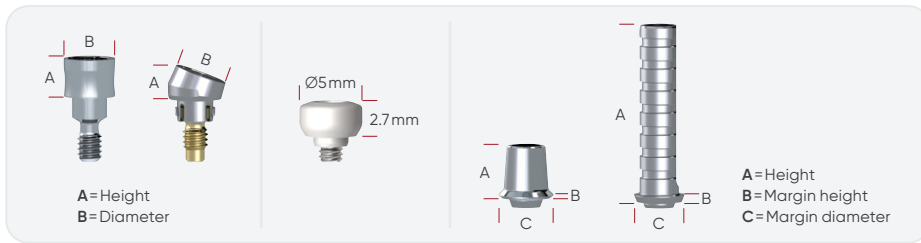

Access Abutments

Clinical screw fixed within the Multi-Unit Abutment

Art. No.	Description	A	B
<i>All Access Abutments include Abutment and a Healing Abutment</i>			
31238	Access Abutment 1.5mm	1.5mm	4mm
31215	Access Abutment 3.0mm	3mm	
31216	Access Abutment 4.0mm	4mm	
31218	Access Abutment 6.0mm	6mm	
31219	Access Abutment 10° 2.6mm	2.6mm	4mm
31243	Access Abutment 10° 4.6mm	4.6mm	
31221	Access Abutment 20° 2.6mm	2.6mm	
31244	Access Abutment 20° 4.6mm	4.6mm	
31223	Access Abutment 30° 2.9mm	2.9mm	
31245	Access Abutment 30° 4.9mm	4.9mm	
31225	Access Impression Coping 8mm and Replica <i>Includes Coping, Screw, Replica, Extension Tube for Open Tray and Plastic Cap for Closed Tray Technique</i>		
31366	Access Impression Coping 13mm and Replica		
90183	Scan Body Neoss® Access (IO 1B-A)		

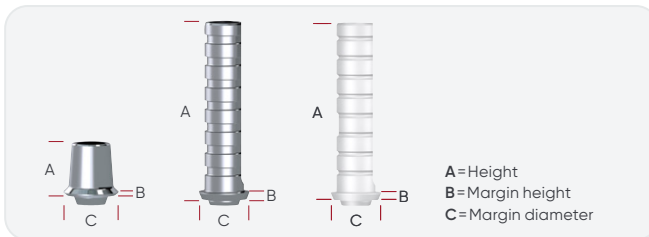

Art. No.	Description	A	B	C
31226	Access Ti NeoLink® Multi	4.3mm	0.3mm	4.5mm
31227	Access Gold NeoLink® Multi <i>31226 and 31227 include NeoLink®, Prosthetic Screw, Provisional/Laboratory Screw and a Plastic Coping</i>	4.7mm	0.7mm	4.5mm
90207	Access Equator Abutment Kit 0.5mm			
90208	Access Equator Abutment Kit 1.5mm			
31301	Access Provisional Ti Abutment Multi <i>Includes Provisional/Laboratory Screw and Straight Coping</i>	15.7mm	0.7mm	4.5mm
31266	Access Burnout Abutment Multi – 2 pcs <i>Includes Straight Coping</i>			

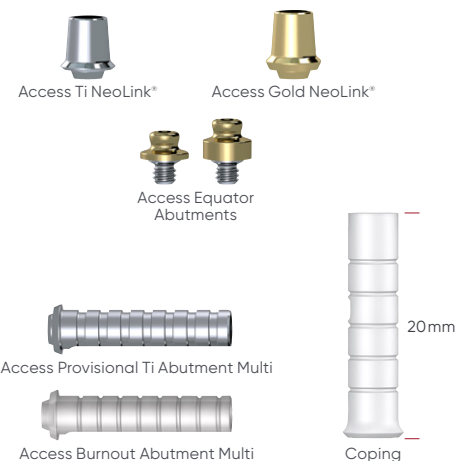

Multi-Unit/Access Screws

Art. No.	Description
31229	Multi-Unit/Access Neo Prosthetic Screw – 1pc
31257	Multi-Unit/Access Neo Provisional/Laboratory Screw – 5 pcs
31265	Multi-Unit/Access Neo Laboratory Screw Long – 5 pcs
31348	Multi-Unit/Access iGO Prosthetic Screw – 1pc
31351	Multi-Unit/Access iGO Laboratory Screw – 1pc

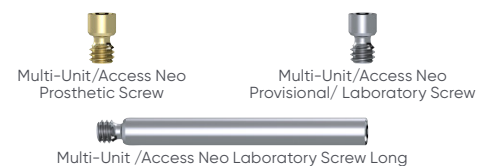

Design control with *total flexibility*



Esthetic Healing Abutment with ScanPeg



Esthetic Healing Abutments



Healing Abutments Ti



Healing Abutment PEEK with Screw



Wide Healing Abutment

Wide Healing Abutment 5mm

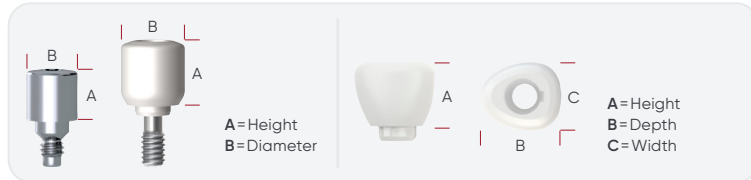

Healing Abutments

Esthetic Healing Abutments with ScanPeg

All Esthetic Healing Abutments include Titanium Screw and a ScanPeg

Art. No.	Description	A	B	C
31360	Esthetic Healing Abutment with ScanPeg – Wide Incisor	5 mm	5.7 mm	6.1 mm
31361	Esthetic Healing Abutment with ScanPeg – Narrow Incisor		5.2 mm	5 mm
31362	Esthetic Healing Abutment with ScanPeg – Canine		6.3 mm	5.4 mm
31363	Esthetic Healing Abutment with ScanPeg – Pre-molar		6.8 mm	5.8 mm
31364	Esthetic Healing Abutment with ScanPeg – Molar		7.8 mm	7.3 mm

Healing Abutments

Art. No.	Description	A	B
31159	Healing Abutment Ti 2mm	2mm	4 mm
31160	Healing Abutment Ti 4mm	4 mm	
31161	Healing Abutment Ti 6mm	6 mm	
31162	Healing Abutment Ti 8mm	8 mm	
31163	Healing Abutment Ti 10mm	10 mm	
31148	Healing Abutment PEEK 5 mm with Screw	5 mm	5 mm
31320	Healing Abutment PEEK 5 mm with Screw, NP	5 mm	4 mm
31321	Wide Healing Abutment PEEK 3.3 mm with Screw	3.3 mm	6.5 mm
31335	Wide Healing Abutment PEEK 5 mm with Screw	5 mm	6.5 mm
31410	Healing Abutment PEEK 2.7 mm with Screw	2.7 mm	2.7 mm



Provisional Abutments

Esthetic Tissue Formers

All Esthetic Tissue Formers include Provisional Screw

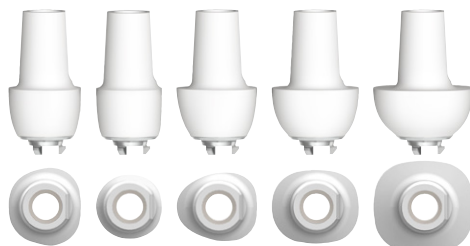

Esthetic Tissue Formers

Art. No.	Description	A	B	C	D
31340	Esthetic Tissue Former – Wide Incisor	10 mm	4 mm	5.7 mm	6.1 mm
31341	Esthetic Tissue Former – Narrow Incisor			5.2 mm	5 mm
31342	Esthetic Tissue Former – Canine			6.3 mm	5.3 mm
31343	Esthetic Tissue Former – Pre-molar			6.8 mm	5.8 mm
31344	Esthetic Tissue Former – Molar			7.8 mm	7.3 mm

Provisional Titanium Abutments

All Provisional Abutments include Provisional Screw and Coping

Art. No.	Description	A	B	C
31267	Provisional Ti Abutment Mono	15.7mm	0.7mm	4.5mm
31268	Provisional Ti Abutment Multi			
31332	Provisional Ti Abutment Mono – Cement Retained	10.7mm	0.7mm	3.8mm
31241	Provisional Ti Abutment, NP <i>Includes Provisional Titanium Abutment, Provisional Screw NP and Neo Laboratory Screw NP</i>			

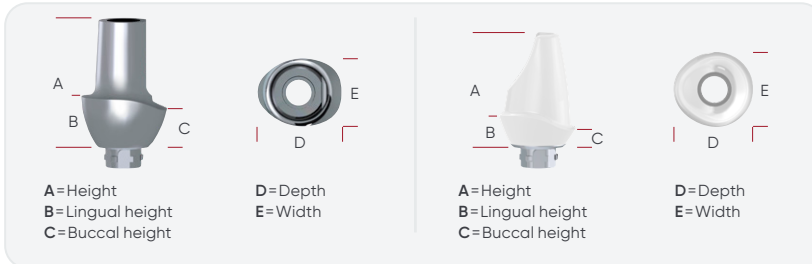
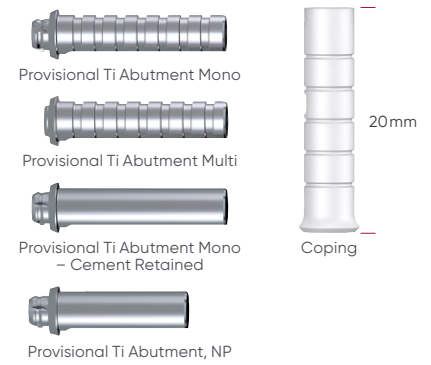

Final Abutments

Prepable Titanium Abutments

All Prepable Abutments include Neo Abutment Screw and Neo Laboratory Screw

Art. No.	Description	A	B	C	D	E
31280	Prepable Ti Abutment 1.5mm 0° – Wide Incisor	8.5mm	2.5mm	1.5mm	5.8mm	6.5mm
31281	Prepable Ti Abutment 1.5mm 15° – Wide Incisor					
31282	Prepable Ti Abutment 1mm 0° – Narrow Incisor	8mm	2mm	1mm	5mm	5.1mm
31283	Prepable Ti Abutment 1mm 15° – Narrow Incisor					
31284	Prepable Ti Abutment 3mm 0° – Narrow Incisor	10mm	4mm	3mm	5.1mm	5.1mm
31285	Prepable Ti Abutment 3mm 15° – Narrow Incisor					
31286	Prepable Ti Abutment 3mm 0° – Canine	10mm	4mm	3mm	6.7mm	5.4mm
31305	Prepable Ti Abutment 1.5mm 0° – Pre-molar	7mm	2mm	1.5mm	6.9mm	5.7mm
31287	Prepable Ti Abutment 3mm 0° – Pre-molar	9mm	3mm	3mm	6.9mm	5.7mm
31306	Prepable Ti Abutment 1.5mm 0° – Molar	7mm	2mm	1.5mm	7.8mm	7.1mm
31288	Prepable Ti Abutment 3mm 0° – Molar	9mm	3mm	3mm	7.8mm	7.1mm
31201	Prepable Ti Abutment 1mm 0°, NP	8mm	2mm	1mm	4mm	
31202	Prepable Ti Abutment 1mm 15°, NP					



Prepable Titanium Abutments, Alternative Emergence Profiles

Art. No.	Description	A	B	C	D	E
31317	Prepable Ti Abutment 2mm 0° – Wide Emergence <i>Includes Neo Abutment Screw, Neo Laboratory Screw, specific Cover Screw and specific Healing Abutment PEEK with Screw. Compatible with Implant diameters Ø5.0 – 6.5mm</i>	9mm	2mm	2mm	7.9mm	7.1mm
31318	Prepable Ti Abutment 1.5mm 0° – Narrow Emergence	8.5mm	2mm	1.5mm	4.4mm	4.5mm
31319	Prepable Ti Abutment 1.5mm 15° – Narrow Emergence <i>All Narrow Emergence Prepable Abutments include Neo Abutment Screw and Neo Laboratory Screw. Only use with Ø3.5 and Ø4.0 mm implants</i>					

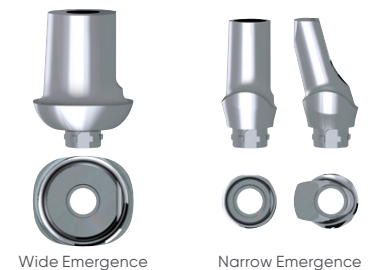



Zirconia Abutments

Zirconia Abutments

All Zirconia Abutments include separate Zirconia Coping, Ti NeoLink® Mono, Neo Abutment Screw and Neo Laboratory Screw

Art. No.	Description	A	B	C	D	E
31290	Zirconia Abutment – Wide Incisor	9mm	2.5mm	1.5mm	5.8mm	6.4mm
31291	Zirconia Abutment – Narrow Incisor				5.4mm	5.1mm
31292	Zirconia Abutment – Canine				6.2mm	5.8mm
31293	Zirconia Abutment – Pre-molar		2mm	2mm	6.4mm	5.5mm
31294	Zirconia Abutment – Molar		7.2mm	6.7mm		

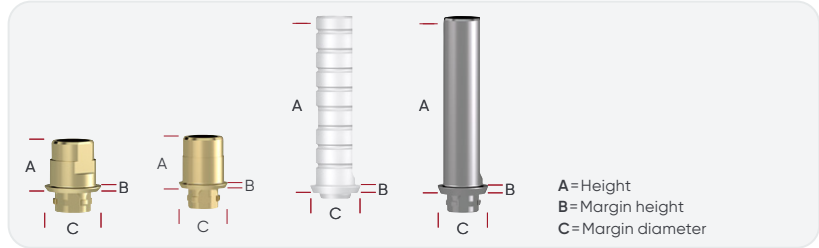

Final Restorations – Casting

Gold NeoLink® (Direct Casting)

Gold NeoLinks include Neo Abutment Screw, Neo Laboratory Screw and Straight Copings

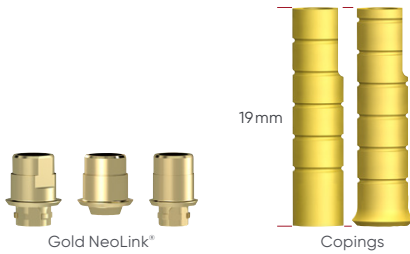

Art. No.	Description	A	B	C
31102	Gold NeoLink® Mono	4.0mm	0.4mm	4.5mm
31103	Gold NeoLink® Multi			3.8mm
31199	Gold NeoLink® Mono, NP <i>Includes Neo Abutment Screw Ti NP, Neo Laboratory Screw NP and a set of Preformed Plastic Copings</i>			



CoCr Abutment Mono



CoCr Abutment Multi



Burnout Abutment Mono



Burnout Abutment Multi



Access Burnout Abutment Multi



Burnout NeoLink® Multi

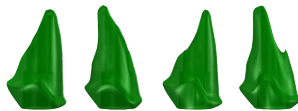

NeoLink® Plastic Copings

CoCr Abutments (Indirect Casting)

CoCr Abutments include Neo Abutment Screw, Neo Laboratory Screw and Straight Coping



Art. No.	Description	A	B	C
31269	CoCr Abutment Mono	15.7mm	0.7mm	4.5mm
31260	CoCr Abutment Multi			

Burnout Abutments (Direct Casting)

31333, 31157 and 31266 include Straight Coping

Art. No.	Description	A	B	C
31333	Burnout Abutment Mono – 2 pcs	15.7mm	0.7mm	4.5mm
31157	Burnout Abutment Multi – 2 pcs			3.8mm
31266	Access Burnout Abutment Multi – 2 pcs			
31255	Burnout NeoLink® Multi NP – 2 pcs <i>Includes set of Preformed Plastic Copings</i>	4.3mm		

Overdenture Abutments

Equator Abutments

All kits include Equator Abutment, Housing with processing Cap, Protector Disk, Standard, Strong, Soft and Extra Soft Retention caps

Art. No. Description

90201	Neoss Equator Abutment Kit 1mm
90202	Neoss Equator Abutment Kit 2mm
90242	Neoss Equator Abutment Kit 2mm, NP
90203	Neoss Equator Abutment Kit 3mm
90243	Neoss Equator Abutment Kit 3mm, NP
90204	Neoss Equator Abutment Kit 4mm
90244	Neoss Equator Abutment Kit 4mm, NP
90205	Neoss Equator Abutment Kit 5mm
90206	Neoss Equator Abutment Kit 6mm
90207	Access Equator Abutment Kit 0.5mm
90208	Access Equator Abutment Kit 1.5mm
90210	Neoss Equator Cap and Housing Kit
90215	Neoss Equator Cap and Housing Kit – Extended Divergence
90211	Neoss Equator Cap Standard Retention, White – 2 pcs
90212	Neoss Equator Cap Strong Retention, Violet – 2 pcs
90213	Neoss Equator Cap Soft Retention, Pink – 2 pcs
90214	Neoss Equator Cap Extra Soft Retention, Yellow – 2 pcs
90220	Neoss Equator Impression Coping & Replica – 2 sets
90222	Neoss Equator Protector Disk – 10 pcs
90232	Neoss Equator Cap Tool



Bar Abutment

Art. No. Description

31168	Bar Abutment Gold <i>Includes Abutment, Neo Abutment Screw and Neo Laboratory Screw</i>
31261	Bar Abutment Ti 14mm <i>Includes Neoss Abutment Screw and Laboratory Screw</i>





LOCATOR® Core Tool



LOCATOR® Impression Coping & Replica



LOCATOR® Replacement Males



LOCATOR® Block Out Spacer



LOCATOR® and Access LOCATOR® Abutment Kit

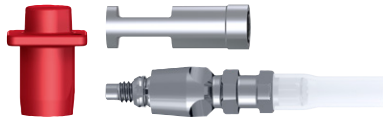

Impression Coping and Replica

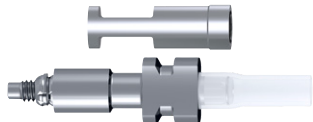

Impression Coping Open Tray and Replica

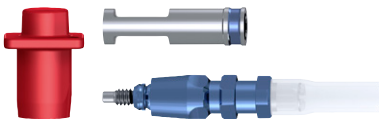

Impression Coping and Replica, NP

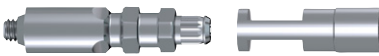

Access Impression Coping and Replica



Impression Coping Cap



Impression Coping Extension Tube

Overdenture LOCATOR® Solution

Art. No. Description

08260	LOCATOR® 35 Ncm Torque Wrench Inserter Driver 15 mm
08393	LOCATOR® core tool
08451	1.0 mm LOCATOR® Abutment for Neoss 4.1 mm D Implant
08452	2.0 mm LOCATOR® Abutment for Neoss 4.1 mm D Implant
08453	3.0 mm LOCATOR® Abutment for Neoss 4.1 mm D Implant
08454	4.0 mm LOCATOR® Abutment for Neoss 4.1 mm D Implant
08455	5.0 mm LOCATOR® Abutment for Neoss 4.1 mm D Implant
08456	6.0 mm LOCATOR® Abutment for Neoss 4.1 mm D Implant
08505	LOCATOR® impression coping (4 pcs)
08519-2	LOCATOR® male processing package assembly (2 pcs)
08524	LOCATOR® replacement male Clear (4 pcs)
08527	LOCATOR® replacement male Light Retention Pink (4 pcs)
08529	LOCATOR® replacement male Extra Light Retention Blue (4 pcs)
08530	LOCATOR® 4 mm female analog (4 pcs)
08547	LOCATOR® replacement male Green (4 pcs)
08548	LOCATOR® replacement male Red (4 pcs)
08913	LOCATOR® Driver Machine, 23 mm

Impressions & Replicas

Impressions Copings

Art. No. Description

31170	Impression Coping 8mm and Replica
31145	Impression Coping 11mm and Replica
31183	Impression Coping 18mm and Replica <i>31170, 31145 and 31183 include Coping, Screw, Replica, Extension Tube for Open Tray and Plastic Cap for Closed Tray Technique</i>
31302	Impression Coping Open Tray 8mm and Replica
31185	Impression Coping Open Tray 13mm and Replica <i>31302 and 31185 include Coping, Screw, Replica and Extension Tube</i>
31197	Impression Coping 11mm and Replica, NP <i>Includes Coping, Screw, Replica, Extension Tube for Open Tray and Plastic Cap for Closed Tray Technique</i>
31442	Multi-Unit Impression Coping Open tray 6mm*
31443	Multi-Unit Impression Coping Closed tray 10mm*
31366	Access Impression Coping 13mm and Replica
31186	Impression Coping Cap Closed Tray – 10 pcs
31262	Impression Coping Extension Tube – 20 pcs

*Not co-packed and should be ordered separately

Replicas

Art. No. Description

31444	Multi-Unit Replica – 5 pcs*
31231	Access Replica – 5 pcs
31146	Implant Replica – 5 pcs
31198	Implant Replica, NP – 5 pcs
31304	Implant Replica, NP – 1pc
31166	Protection Replica – 1pc

*Not co-packed and should be ordered separately

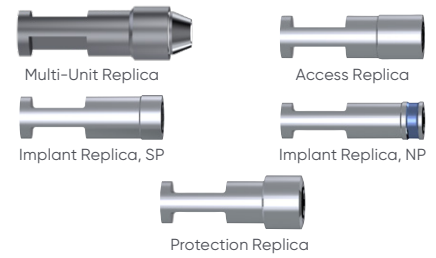

Screws

Art. No. Description

31258	Neo Abutment Screw, SP – 1pc	
31259	Neo Abutment Screw, SP – 5 pcs	
31240	Neo Abutment Screw Ti, NP – 1pc	
31149	Neo Laboratory Screw, SP – 5 pcs	
31239	Neo Laboratory Screw, NP – 1pc	
31303	Neo Laboratory Screw Long, SP – 5 pcs	
31347	iGO Abutment Screw, SP – 1pc	
31349	iGO Abutment Screw, NP – 1pc	
31348	Multi-Unit/Access iGO Prosthetic Screw – 1pc	
31350	iGO Laboratory Screw, SP – 1pc	
31352	iGO Laboratory Screw, NP – 1pc	
31351	Multi-Unit/Access iGO Laboratory Screw – 1pc	
31229	Multi-Unit/Access Neo Prosthetic Screw – 1pc	
31257	Multi-Unit/Access Neo Provisional/Laboratory Screw – 5 pcs	
31265	Multi-Unit/Access Neo Laboratory Screw Long – 5 pcs	



The instruments *you need*



Round Bur



Lance Drill



Pilot Drill



Twist Drill, Straight



Twist Drill, Tapered



Drill Stop

Drills

Art. No. Description

41153	Round Bur Ø1.8 mm	
41152	Lance Drill Ø1.5×3/5/7 mm	
41170	Pilot Drill Ø2.2/3.0 mm	
41154	Twist Drill, Straight Ø2.2×7 – 17 mm	
41156	Twist Drill, Straight Ø2.85×7 – 17 mm	
41157	Twist Drill, Straight Ø3.0×7 – 17 mm	
41158	Twist Drill, Straight Ø3.2×7 – 17 mm	
41159	Twist Drill, Straight Ø3.4×7 – 17 mm	
41160	Twist Drill, Straight Ø3.6×7 – 17 mm	
41161	Twist Drill, Straight Ø3.9×7 – 17 mm	
41162	Twist Drill, Straight Ø4.1×7 – 17 mm	
41163	Twist Drill, Straight Ø4.4×7 – 17 mm	
41164	Twist Drill, Straight Ø4.6×7 – 17 mm	
41165	Twist Drill, Straight Ø4.9×7 – 17 mm	
41166	Twist Drill, Straight Ø5.1×7 – 17 mm	
41205	Twist Drill, Straight Ø6.0×7 – 11 (13) mm	
41193	Drill Kit, Straight Implants Ø3.5 – 5.0 <i>Includes Twist Drills Ø2.2, 3.0, 3.4, 3.9 and 4.4</i>	
41172	Twist Drill, Tapered Ø3.0×7 – 17 mm	1.9 mm
41173	Twist Drill, Tapered Ø3.4×7 – 17 mm	2.3 mm
41174	Twist Drill, Tapered Ø3.9×7 – 17 mm	2.8 mm
41175	Twist Drill, Tapered Ø4.4×7 – 17 mm	Ø 3.3 mm
41176	Twist Drill, Tapered Ø4.9×7 – 17 mm	3.8 mm
41206	Twist Drill, Tapered Ø5.5×7 – 17 mm	4.3 mm
41204	Twist Drill, Tapered Ø5.5×7 – 11 (13) mm	4.3 mm
41192	Drill Kit, Tapered Implants Ø3.5 – 5.0 <i>Includes Twist Drills Ø2.2 S, 3.0 T, 3.4 T, 3.9 T and 4.4 T</i>	
41177	Drill Kit, Edge Implants Ø3.5 – 5.0 <i>Includes Twist Drills Ø2.2 S, 3.0 T, 3.4 T, 3.9 T and 4.4 T</i>	
41142	Drill Stop 7 mm Ø2.2, 3.0, 3.4, 3.9 and 4.4 mm	
41143	Drill Stop 9 mm Ø2.2, 3.0, 3.4, 3.9 and 4.4 mm	
41144	Drill Stop 11 mm Ø2.2, 3.0, 3.4, 3.9 and 4.4 mm	
41145	Drill Stop 13 mm Ø2.2, 3.0, 3.4, 3.9 and 4.4 mm	
41146	Drill Stop 15 mm Ø2.2, 3.0, 3.4, 3.9 and 4.4 mm	
41215	Twist Drill, Straight Ø2.2×7 – 17 mm	
41216	Twist Drill, Straight Ø2.85×7 – 17 mm	
41217	Twist Drill, Straight Ø3.0×7 – 17 mm	
41218	Twist Drill, Straight Ø3.2×7 – 17 mm	
41219	Twist Drill, Straight Ø3.4×7 – 17 mm	
41220	Twist Drill, Straight Ø3.6×7 – 17 mm	
41221	Twist Drill, Straight Ø3.9×7 – 17 mm	
41222	Twist Drill, Straight Ø4.1×7 – 17 mm	
41223	Twist Drill, Straight Ø4.4×7 – 17 mm	
41224	Twist Drill, Straight Ø4.6×7 – 17 mm	
41225	Twist Drill, Straight Ø4.9×7 – 17 mm	
41226	Twist Drill, Straight Ø5.1×7 – 17 mm	

Single Use

Multiple Use

Art. No. Description

41233	Drill Kit, Straight Implants Ø3.5 – 5.0 <i>Includes Twist Drills Ø2.2, 3.0, 3.4, 3.9 and 4.4</i>	
41184	Drill Kit, Straight – Short 7 – 13 mm <i>Includes Twist Drills Ø2.2, 3.0, 3.4, 3.9, 4.4 and 4.9</i>	
41227	Twist Drill, Tapered Ø3.0 × 7 – 17 mm	1.9 mm
41228	Twist Drill, Tapered Ø3.4 × 7 – 17 mm	2.3 mm
41229	Twist Drill, Tapered Ø3.9 × 7 – 17 mm	2.8 mm
41230	Twist Drill, Tapered Ø4.4 × 7 – 17 mm	3.3 mm
41231	Twist Drill, Tapered Ø4.9 × 7 – 17 mm	3.8 mm
41232	Twist Drill, Tapered Ø5.5 × 7 – 17 mm	4.3 mm
41235	Drill Kit, Tapered Implants Ø3.5 – 5.0 <i>Includes Twist Drills Ø2.2S, 3.0T, 3.4T, 3.9T and 4.4T</i>	
41191	Drill Kit Tapered – Short 7 – 13 mm <i>Includes Twist Drills Ø2.2S, 3.0T, 3.4T, 3.9T, 4.4T, and 4.9T</i>	
41236	Drill Kit, Edge Implants Ø3.5 – 5.0 <i>Includes Twist Drills Ø2.2S, 3.0T, 3.4T, 3.9T and 4.4T</i>	
41139	Countersink, Straight Ø3.25	2.7 mm
41110	Countersink, Straight Ø3.5	2.9 mm
41111	Countersink, Straight Ø4.0	3.3 mm
41112	Countersink, Straight Ø4.5	3.5 mm
41133	Countersink, Straight Ø5.0	4.3 mm
41127	Countersink, Straight Ø5.5	4.7 mm
41178	Countersink, Tapered Ø3.5	2.0 mm
41179	Countersink, Tapered Ø4.0	2.8 mm
41180	Countersink, Tapered Ø4.5	3.3 mm
41181	Countersink, Tapered Ø5.0	3.7 mm
41182	Countersink, Tapered Ø5.5	4.2 mm
41210	Countersink, Edge Ø3.5	1.8 mm
41211	Countersink, Edge Ø4.0	2.6 mm
41212	Countersink, Edge Ø4.5	3.0 mm
41213	Countersink, Edge Ø5.0	3.5 mm
41202	Countersink Ø6.0	4.8 mm
41201	Countersink Ø6.5	5.2 mm
41113	Screw Tap Ø3.5	
41114	Screw Tap Ø4.0	
41115	Screw Tap Ø4.5	
41134	Screw Tap Ø5.0	
41126	Screw Tap Ø5.5	
41140	Screw Tap Ø3.25	
41237	Bone Profiler Ø5.1 mm, SP	
41238	Bone Profiler Ø6.6 mm, SP	
41239	Bone Profiler Ø4.1 mm, NP	
41240	Bone Remover Cover Screw, SP	
41241	Bone Remover Cover Screw, NP	

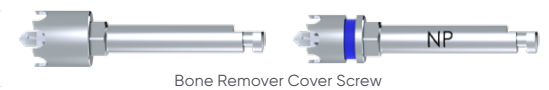
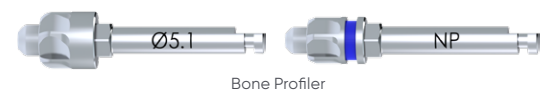
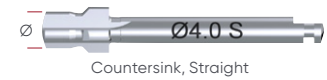



Neoss Prosthetic Tray – Neo



Neoss ProActive® Implant System Box

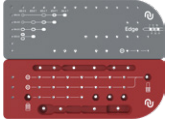

ProActive® Edge

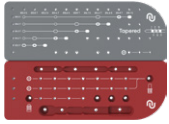

ProActive® Tapered

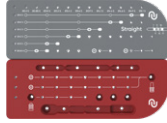

ProActive® Straight



Neoss Prosthetic Instrument Kit – Neo



Drill and Surgical Instrument Kit, Edge



Drill and Surgical Instrument Kit, Tapered



Drill and Surgical Instrument Kit, Straight

Kits

Surgical & Prosthetic Trays

Art. No. Description

51180	Neoss Prosthetic Tray – Neo
51186	Neoss ProActive® Implant System Box
51189	Neoss Surgical and Prosthetic Tray – ProActive® Edge
51188	Neoss Surgical and Prosthetic Tray – ProActive® Tapered
51187	Neoss Surgical and Prosthetic Tray – ProActive® Straight

Surgical & Prosthetic Kits with instruments and drills

Art. No. Description

51181	Neoss Prosthetic Instrument Kit – Neo <i>Includes Prosthetic Tray, Ratchet, Screwdriver Machine 22mm, Screwdriver Machine 32mm, Screwdriver Manual 15mm and Manual Handle</i>
41151	Surgical Instrument Kit <i>Includes art no 41120, 51118, 51119, 51144, 51139, 51140, 51125, 51126</i>
41254	Drill and Surgical Instrument Kit, Edge Implants Ø3.5 – 5.0 <i>Single use twist drills. Includes art no 41177, 41210, 41211, 41212, 41213, 41237, 41238, 41240, 41151, 41153, 41152, 41170, 51121, 51137, 51141, 51186, 51189 and 51190</i>
41253	Drill and Surgical Instrument Kit, Edge Implants Ø3.5 – 5.0 <i>Multiple use twist drills. Includes art no 41236, 41210, 41211, 41212, 41213, 41237, 41238, 41240, 41151, 41153, 41152, 41170, 51121, 51137, 51141, 51186, 51189 and 51190</i>
41252	Drill and Surgical Instrument Kit, Tapered Implants Ø3.5 – 5.0 <i>Single use twist drills. Includes art no 41192, 41158, 41160, 41162, 41164, 41178, 41179, 41180, 41181, 41151, 41153, 41152, 41170, 51121, 51137, 51141, 51186, 51188 and 51190</i>
41251	Drill and Surgical Instrument Kit, Tapered Implants Ø3.5 – 5.0 <i>Multiple use twist drills. Includes art no 41235, 41218, 41220, 41222, 41224, 41237, 41238, 41240, 41178, 41179, 41180, 41181, 41151, 41153, 41152, 41170, 51121, 51137, 51141, 51186, 51188 and 51190</i>
41248	Drill and Surgical Instrument Kit, Straight Implants Ø3.5 – 5.0 <i>Single use twist drills. Includes art no 41193, 41158, 41160, 41162, 41164, 41110, 41111, 41112, 41133, 41151, 41170, 41153, 41152, 41237, 41238, 41240, 51121, 51137, 51141, 51186, 51187 and 51190</i>
41247	Drill and Surgical Instrument Kit, Straight Implants Ø3.5 – 5.0 <i>Multiple use twist drills. Includes art no 41233, 41218, 41220, 41222, 41224, 41110, 41111, 41112, 41133, 41151, 41170, 41153, 41152, 41237, 41238, 41240, 51121, 51137, 51141, 51186, 51187 and 51190</i>
41250	Drill and Surgical Instrument Kit, Straight Implants NP Ø3.25 <i>Single use twist drills. Includes art no 41154, 41156, 41157, 41139, 51142, 51145, 41241, 41239, 41170, 41153, 41152, 51121, 51137, 41120, 51144, 51125, 51139, 51140, 51141, 51126, 51190, 51186 and 51187</i>
41249	Drill and Surgical Instrument Kit, Straight Implants NP Ø3.25 <i>Multiple use twist drills. Includes art no 41215, 41216, 41217, 41139, 51142, 51145, 41241, 41239, 41170, 41153, 41152, 51121, 51137, 41120, 51144, 51125, 51139, 51140, 51141, 51126, 51190, 51186 and 51187</i>
41256	Drill and Surgical Instrument Add-On-Kit, Straight Implant Ø3.25 <i>Single use twist drills. Includes art no 41156, 41239, 41241, 41139, 51142 and 51145</i>
41255	Drill and Surgical Instrument Add-On-Kit, Straight Implant Ø3.25 <i>Multiple use twist drills. Includes art no 41216, 41239, 41241, 41139, 51142 and 51145</i>



Drill and Surgical Instrument Kits also includes the prosthetic instruments and a Depth Gauge Probe. All in one box for your convenience.

Guide

Art. No. Description

51154	Neoss® Guide Kit Ø3.5 – Ø6.0 <i>(Neoss Implants Ø3.5 – Ø6.0 mm, 7 – 15 mm lengths.) Includes 5 × Drill-Hubs, 2 × Countersink Conduits, 4 × Implant Mount Ø5.0 S9, 2 × Implant Mount Ø6.0 S9, 7 × Guide Keys, 3 × Guide Key Adapter, 1 × Holder Guide Key Adapter. Spare parts available, contact local representative for details</i>
51173	Neoss® Guide – Implant Mount SP, Ø5.0 S9 – 2 pcs
51174	Neoss® Guide – Implant Mount SP, Ø6.0 S9 – 2 pcs
51156	Neoss® Guide – Sleeve Ø5.0 – 10 pcs
51157	Neoss® Guide – Sleeve Ø6.0 – 5 pcs
51155	Neoss® Guide – Implant Inserter, SP <i>For partially guided only, see IFU</i>



Neoss® Guide Kit



Implant Mount



Sleeve



Implant Inserter

Neoss® Guide Kit – SPARE PARTS

Art. No. Description

51160	Neoss® Guide – Drill-Hub I
51161	Neoss® Guide – Drill-Hub II
51162	Neoss® Guide – Drill-Hub III
51163	Neoss® Guide – Drill-Hub IV
51164	Neoss® Guide – Drill-Hub V
51165	Neoss® Guide – Guide Key Ø2.2/2.85
51166	Neoss® Guide – Guide Key Ø3.0/3.2
51167	Neoss® Guide – Guide Key Ø3.4/3.6
51168	Neoss® Guide – Guide Key Ø3.9/4.1
51169	Neoss® Guide – Guide Key Ø4.4/4.6
51170	Neoss® Guide – Guide Key Ø4.9/5.1
51178	Neoss® Guide – Guide Key Ø5.5
51171	Neoss® Guide – Countersink Conduit Ø5.0
51172	Neoss® Guide – Countersink Conduit Ø6.0
51176	Neoss® Guide – Guide Key Adapter – 2 pcs
51177	Neoss® Guide – Holder Guide Key Adapter
51158	Drill Sleeve Ø2.2 – 10 pcs



Drill-Hubs



Guide Key



Countersink Conduit



Drill Sleeve



Guide Key Adapter



Holder Guide Key Adapter

Demo Kit

Art. No. Description

61150	King Size Dummy Kit <i>Includes Neoss Straight, Tapered and Edge Implants, implant inserter, screwdriver, abutment screw, NeoLink® Abutment, Esthetic Healing Abutment Narrow Incisor with ScanPeg and crown</i>
-------	---



King Size Dummy Kit

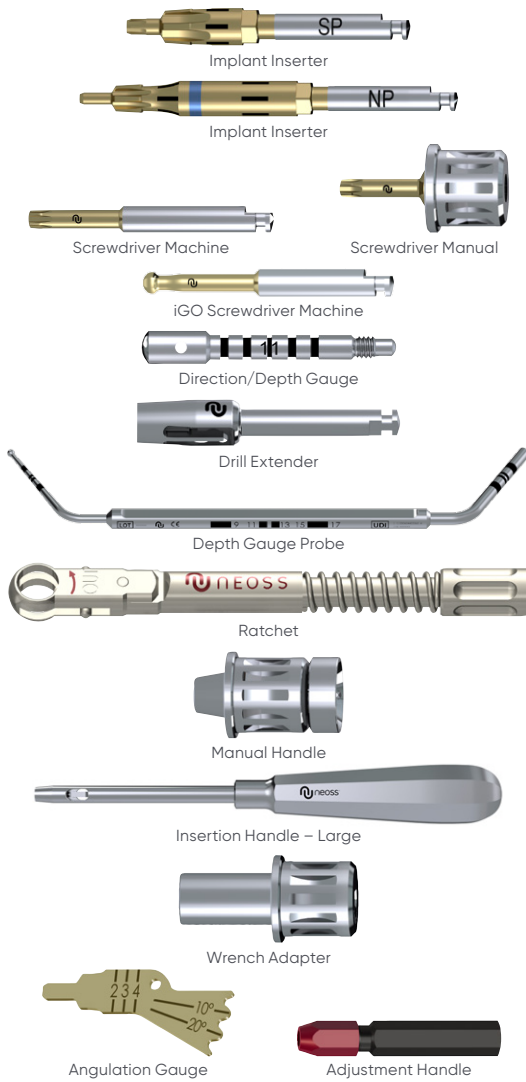

Instruments

Art. No.	Description
51137	Implant Inserter, SP 17 mm
51118	Implant Inserter, SP 22 mm
51119	Implant Inserter, SP 32 mm
51145	Implant Inserter, NP 24 mm
51142	Implant Inserter, NP 32 mm
51139	Neo Screwdriver, Machine 22 mm
51140	Neo Screwdriver, Machine 32 mm
51141	Neo Screwdriver, Manual 15 mm
51183	iGO Screwdriver, Machine 22 mm
51184	iGO Screwdriver, Machine 32 mm
51125	Direction/Depth Gauge – 4 pcs
41120	Drill Extender
51190	Depth Gauge Probe
51121	Ratchet
51126	Manual Handle
51191	Insertion Handle – Large
51144	Wrench Adapter
51149	Angulation Gauge, SP
90138	Adjustment Handle
41214	X-ray Planner ProActive Edge Implants
41119	X-ray Planner ProActive Straight Implants
41183	X-ray Planner ProActive Tapered Implants
41203	X-ray Planner Ø6.0 Implants
41200	X-ray Planner Ø6.5 Implants

NEO

iGO

Prosthetic Solution Standard and Narrow Platform, overview

Overview Prosthetic Solutions, SP and NP (Ø3.25 – 6.5 Implants)



		Units		Retention		Implant platform		Level			Material					Angulated screw channel	Esthetiline	
		Mono	Multi	Cement retained	Screw retained	SP	NP	Implant level	Access level	Multi-Unit Abutment level	Ti	ZrO	Gold	CoCr	Polymer			
Provisional Restorations	Provisional Ti Abutment	☑	☑	☑	☑	☑	☑	☑	☑	☑	☑							
	Esthetic Tissue Former	☑		☑	☑	☑		☑						☑			☑	
	Healing Cap									☑								
Final Restorations	Prefabricated	Prepable Ti Abutment	☑		☑	☑	☑	☑	☑			☑						☑
		Zirconia Abutment	☑		☑	☑	☑		☑				☑					☑
		Access Abutment (0 – 30°)		☑		☑	☑		☑			☑						
		Multi-Unit Abutment		☑		☑	☑		☑			☑						
	Digital	NeoBase® (SSC, ASC*)	☑	☑	☑	☑	☑	☑	☑		☑	☑					☑	☑
		TiBase**	☑		☑	☑	☑	☑	☑			☑						
		Ti NeoLink®	☑	☑	☑	☑	☑	☑	☑	☑		☑						☑
		Blanks	☑		☑	☑	☑	☑	☑			☑			☑			☑
	Casting	Individual Prosthetics* central milling	☑	☑	☑	☑	☑	☑	☑	☑	☑	☑	☑			☑		☑
		Gold NeoLink®	☑	☑		☑	☑	☑	☑	☑				☑				☑
Burnout Abutment		☑	☑	☑	☑	☑	☑	☑	☑									
Overdenture	CoCr Abutment	☑	☑	☑	☑	☑		☑						☑				
	Equator Abutment		☑			☑	☑	☑	☑									
	Ball Abutment		☑			☑		☑	☑									
	Bar Abutment		☑			☑		☑										

* Utilise iGO Abutment Screw and Screwdriver for angulated screw channels, optional for straight screw channels on Individual Prosthetics milled by Neoss
 ** Compatible with Dentsply Sirona®

Torque and Speed recommendation, overview

Neoss Implant System Torque Recommendation (Ncm)

Implants	Screw Taps	Healing			Provisional		Impression	Final restoration					
		Cover Screw	Healing Abutment PEEK and Esthetic Healing Abutment	Healing Abutment Ti	Esthetic Tissue Former	Provisional Ti Abutment		Impression Coping Screw	Neo Abutment Screw	Multi-Unit and Access Abutment Straight & Angulated	Multi-Unit and Neo Access Prosthetic Screw	Ball Abutment including Access level	Equator Abutment
45 Max	40 – 45	10 Max	10 Max	10 Max	20	20	10 Max	32*	32	20	20	32	20
												Implant level	Access level
												32	20

* 35 Ncm optional for high-load cases

Final restoration with iGO Screws		
iGO Abutment Screw, SP	iGO Abutment Screw, NP	iGO Prosthetic Screw, Access
32	20	20

Neoss Implant System Drilling/Insertion Speed Recommendation (rpm)

Drills	Screw Taps	Countersinks	Implants	Bone Mill
800 – 2000**	20	800	20 Max	40 Max

** lower speed for larger drills

Symbols, names and abbreviations



SP = Standard Platform Ø3.5 – 6.5 Implants

NP = Narrow Platform Ø3.25 Implants

iGO = utilises iGO Screw and Screwdriver

Neo = Neoss standard Screw/Screwdriver

SSC = Straight Screw Channel

ASC = Angulated Screw Channel

You can now buy your products online!

Products can also be ordered online at neoss.com.

Some products may not be regulatory or commercially available for all markets and available in limited quantities. Contact your local representative for availability and prices.

Disclaimer of Liability

Neoss products may only be used according to the manufacturers' instructions and recommendations.

The user of Neoss products should determine their suitability for particular patients and indications.

Neoss Limited disclaims any liability, expressed or implied, and shall have no responsibility for any direct, indirect, punitive or other damages arising out of or in connection with any errors in professional judgment or practice in the use or placement of the Neoss products.

Product images are not to scale and are subject to change.

All dimensions are for identification purposes only.

Copyrights, design rights and trademarks:

Neoss documents, software and designs may not be reprinted, copied or published in whole or part, without the written authorisation of Neoss Limited.

Neoss, 'N' logo, NeoGen, NeoLink, NeoLoc, NeoBase and Neoss ProActive are registered trademarks of Neoss Group. NeoScan is a trademark of Neoss Group.

THE Graft™ is a trademark of Purgo Biologics Inc. Biotex® is a registered trademark by Purgo Biologics Inc.

Elos Accurate is a registered trademark of Elos Medtech AB.



Do you want to *lower your inventory costs* and minimize confusion?

NeossONE® is a solution unique to the Neoss implant system – one prosthetic platform, across three implant designs. Simply put, the same prosthetic components fit every implant. The benefits are clear: reducing patient treatment time, optimizing inventory control and minimized product confusion.

- ✓ Reduce steps, saves time
- ✓ Less inventory and maximum flexibility
- ✓ Minimize confusion and mistakes
- ✓ Cost-effective solution for all



NeossONE®



Order your products
24/7 in our Online Store
at shop-us.neoss.com



For our Terms & Conditions consult your local website on www.neoss.com

Contact your local representative for product availability details.
All products are not available in every market.

UNITED STATES

Neoss Inc.

890 Winter Street, Suite 120, Waltham, MA 02451

T: +1 866 626 -3677

E: marketingusa@neoss.com

E: NeoScan: neossupport.us@neoss.com

10502_24 US 2023-08 © Neoss Limited, 2023. Copyrights, design rights and trademarks, Neoss documents, software and designs may not be reprinted, copied or published in whole or part, without the written authorisation of Neoss Limited.