



Produktkatalog

2023



Upptäck

Intelligent Simplicity

Neoss erbjuder intelligenta lösningar som är intuitivt enkla att använda. Våra produkter gör det möjligt för tandläkare att tillhandahålla tillförlitliga och kostnadseffektiva behandlingar till sina patienter med förutsägbara långsiktiga resultat. Vi leder marknaden med uppfinningsrikedom och integritet och strävar efter att sätta nya standarder i att utveckla smarta behandlingslösningar och arbeta nära våra kunder. Neoss gör det komplexa mindre komplicerat. Vi kallar det Intelligent Simplicity.

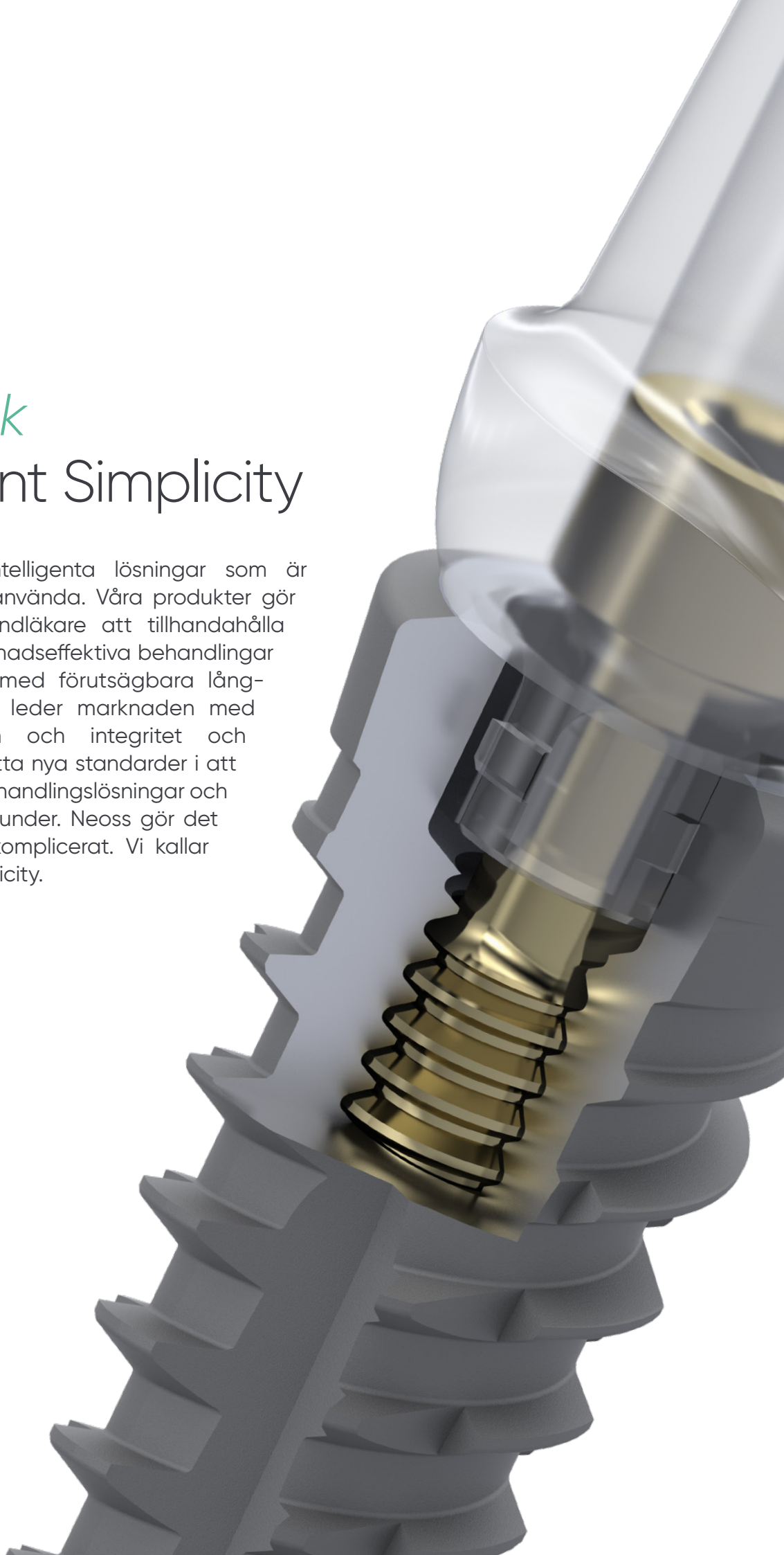

Implantat	4	Neoss ProActive® Edge implantat		
	6	Neoss ProActive® Tapered implantat Neoss ProActive® breda implantat Neoss ProActive® sinusimplantat		
	7	Neoss ProActive® Straight implantat		
	8	Neoss ProActive® Straight NP Ø3.25 implantat Täckskruv		
	Biomaterial	9	Benersättning THE Graft™ i ampull THE Graft™ i spruta THE Graft™ i block Resorberbara membran Kollagen Sårbehandling	
		10	Icke resorberbara membran Titanförstärkta PTFE-membran NeoGen® Cape Icke förstärkta PTFE-membran Fixeringskit	
		11	Suturer Biotex® Neoss PTFE	
		Digitalt	12	NeoScan Digitala avtryck Estetisk läkdistans med ScanPeg ScanPeg Scan Body
13			Analog Digital protetik Temporära distanser NeoBase®-distanser SSC (Straight Screw Channel)	
14			NeoBase®-distanser ASC (Angulated Screw Channel) Neoss TiBase-distanser (kompatibla med Dentsply Sirona®) Ti NeoLink® Individuella lösningar Neoss NT Blanks	
15			Neoss individuell protetik – drivs av ARC solutions	
Protetik			16	Läkdistanser Estetisk läkdistans med ScanPeg Läkdistanser Temporär protetik Temporära distanser
			17	Esthetic Tissue Formers Permanent distanser Preparerbara titandistanser Preparerbara titandistanser, alternativa mjukvävnadsformer
			18	Zirconia-distanser Permanent protetik – gjutning Gold NeoLink® (för direkt gjutning) CoCr-distanser (för indirekt gjutning) Distanser för urbränning (för direkt gjutning)
			19	För skruvretinerade broar Access-distanser (raka och vinklade skruvkanaler)
	20		Täckprotes-distanser Equator-distanser	
	21		Bar-distanser Avtryckstoppar & analoger Avtryckstoppar Analoger	
	22	Skrubar		
	Instrument & tillbehör	23	Borr	
		25	Kit Brickor – kirurgi och protetik Brickor & brickor med instrument-kit	
		26	Guide Neoss® Guide Kit – RESERVDELAR Demo-kit	
27		Instrument ISQ (Implant Stability Quotient) Neoss Penguin ^{®RA}		
Support		28	Protetiska komponenter Standard och Narrow Plattform – översikt Rekommenderade åtdragningsmoment och borrhastigheter – översikt	
	29	Symboler, namn och förkortningar Du kan nu köpa dina produkter online! Ansvarsfrihet		
	32	Kontakt		

Neoss ProActive[®] ytan – *Beprövad och förutsägbar* implantatbehandling för alla patienter sedan 2009

ProActive är en modern superhydrofil och ultraren implantatyta, som introducerades redan 2009. ProActive har bevisade goda kliniska resultat och stöds av långtidsdata¹.

☑ Ultraren, superhydrofil och berikad med magnesium-joner

- Snabbare och starkare osseointegrering²
- Bibehållen implantatstabilitet under läkning³

☑ Definierad yta (blåstrad och etsad) med lägre ytråhet vid implantatkragen

- Stabila bennivåer över tid⁴
- Klinisk 10-års data på > 1200 patienter visar > 98 % implantatöverlevnad^{4,5,6}



1) Engman F et al. *Letters Impl Dent.* 2022;2:6-11. 2) Sennerby L et al. *Letters Impl Dent.* 2017;1:7-10.
 3) Vanden Bogaerde L et al. *Int J Dent.* 2016;84:24931. 4) Sahlin H et al. *Letters Impl Dent.* 2022;2:18-24.
 5) Sennerby L et al. *Letters Impl Dent.* 2022;2:29-32. 6) Hassfurth N et al. *Clin Oral Implants Res.* 2021;32(S22):156-157.

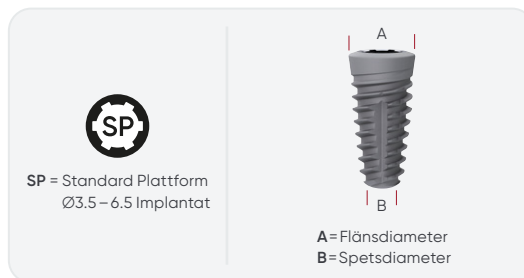

Neoss Implantat

Innehåller implantat och täckskruv.



Neoss ProActive[®] Edge implantat

Art. Nr.	Benämning	A	B
21417	Implantat – Neoss ProActive [®] Edge Ø3.5 × 9 mm		
21418	Implantat – Neoss ProActive [®] Edge Ø3.5 × 11 mm		
21419	Implantat – Neoss ProActive [®] Edge Ø3.5 × 13 mm	4.0 mm	1.6 mm
21420	Implantat – Neoss ProActive [®] Edge Ø3.5 × 15 mm		
21423	Implantat – Neoss ProActive [®] Edge Ø4.0 × 9 mm		
21424	Implantat – Neoss ProActive [®] Edge Ø4.0 × 11 mm	4.3 mm	1.9 mm
21425	Implantat – Neoss ProActive [®] Edge Ø4.0 × 13 mm		
21426	Implantat – Neoss ProActive [®] Edge Ø4.0 × 15 mm		
21429	Implantat – Neoss ProActive [®] Edge Ø4.5 × 9 mm		
21430	Implantat – Neoss ProActive [®] Edge Ø4.5 × 11 mm	4.9 mm	2.2 mm
21431	Implantat – Neoss ProActive [®] Edge Ø4.5 × 13 mm		
21432	Implantat – Neoss ProActive [®] Edge Ø4.5 × 15 mm		
21435	Implantat – Neoss ProActive [®] Edge Ø5.0 × 9 mm		
21436	Implantat – Neoss ProActive [®] Edge Ø5.0 × 11 mm	5.4 mm	2.4 mm
21437	Implantat – Neoss ProActive [®] Edge Ø5.0 × 13 mm		
21438	Implantat – Neoss ProActive [®] Edge Ø5.0 × 15 mm		



SP = Standard Plattform
Ø3.5–6.5 Implantat



A = Flänsdiameter
B = Spetsdiameter

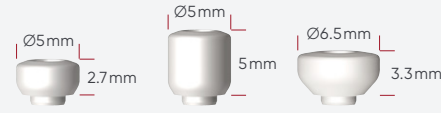

Implantat-kit Ø3.5–4.5

Implantat-kit Ø5.0

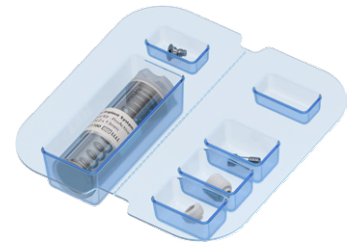

Neoss Implantat-kit

Kitet innehåller implantat, täckskruv, läkdistsans av PEEK i två storlekar och en läkdistsansskruv.

Neoss ProActive® Edge implantat

Art. Nr.	Benämning	A	B
21301	Implantat-kit – Neoss ProActive® Edge Ø3.5×9 mm		
21302	Implantat-kit – Neoss ProActive® Edge Ø3.5×11 mm	4.0 mm	1.6 mm
21303	Implantat-kit – Neoss ProActive® Edge Ø3.5×13 mm		
21304	Implantat-kit – Neoss ProActive® Edge Ø3.5×15 mm		
21305	Implantat-kit – Neoss ProActive® Edge Ø4.0×9 mm		
21306	Implantat-kit – Neoss ProActive® Edge Ø4.0×11 mm	4.3 mm	1.9 mm
21307	Implantat-kit – Neoss ProActive® Edge Ø4.0×13 mm		
21308	Implantat-kit – Neoss ProActive® Edge Ø4.0×15 mm		
21309	Implantat-kit – Neoss ProActive® Edge Ø4.5×9 mm		
21310	Implantat-kit – Neoss ProActive® Edge Ø4.5×11 mm	4.9 mm	2.2 mm
21311	Implantat-kit – Neoss ProActive® Edge Ø4.5×13 mm		
21312	Implantat-kit – Neoss ProActive® Edge Ø4.5×15 mm		
21313	Implantat-kit – Neoss ProActive® Edge Ø5.0×9 mm		
21314	Implantat-kit – Neoss ProActive® Edge Ø5.0×11 mm	5.4 mm	2.4 mm
21315	Implantat-kit – Neoss ProActive® Edge Ø5.0×13 mm		
21316	Implantat-kit – Neoss ProActive® Edge Ø5.0×15 mm		



ProActive Edge Ø3.5



ProActive Edge Ø4.0



ProActive Edge Ø4.5



ProActive Edge Ø5.0

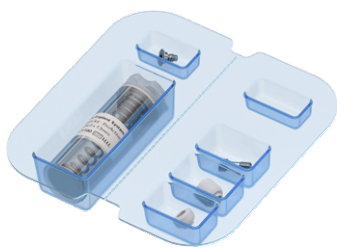

Neoss Implantat-kit

Kitet innehåller implantat, täckskruv, läkdistans (Ø5.0 – 5.5 kit innehåller en bredare variant) av PEEK i två storlekar och en läkdistansskruv.



Neoss ProActive® Tapered implantat

Art. Nr.	Benämning	A	B
21221	Implantat-kit – Neoss ProActive® Tapered Ø3.5×9mm		
21222	Implantat-kit – Neoss ProActive® Tapered Ø3.5×11mm	4.0mm	2.1mm
21223	Implantat-kit – Neoss ProActive® Tapered Ø3.5×13mm		
21224	Implantat-kit – Neoss ProActive® Tapered Ø3.5×15mm		
21227	Implantat-kit – Neoss ProActive® Tapered Ø4.0×9mm		
21228	Implantat-kit – Neoss ProActive® Tapered Ø4.0×11mm	4.3mm	2.3mm
21229	Implantat-kit – Neoss ProActive® Tapered Ø4.0×13mm		
21230	Implantat-kit – Neoss ProActive® Tapered Ø4.0×15mm		
21233	Implantat-kit – Neoss ProActive® Tapered Ø4.5×9mm		
21234	Implantat-kit – Neoss ProActive® Tapered Ø4.5×11mm	4.9mm	2.8mm
21235	Implantat-kit – Neoss ProActive® Tapered Ø4.5×13mm		
21236	Implantat-kit – Neoss ProActive® Tapered Ø4.5×15mm		
21239	Implantat-kit – Neoss ProActive® Tapered Ø5.0×9mm		
21240	Implantat-kit – Neoss ProActive® Tapered Ø5.0×11mm	5.4mm	3.3mm
21241	Implantat-kit – Neoss ProActive® Tapered Ø5.0×13mm		
21242	Implantat-kit – Neoss ProActive® Tapered Ø5.0×15mm		
21245	Implantat-kit – Neoss ProActive® Tapered Ø5.5×9mm		
21246	Implantat-kit – Neoss ProActive® Tapered Ø5.5×11mm	5.9mm	3.8mm
21247	Implantat-kit – Neoss ProActive® Tapered Ø5.5×13mm		

Neoss ProActive® breda implantat

Art. Nr.	Benämning	A	B
21252	Implantat-kit – Neoss ProActive® Ø6.0×7mm		4.5mm
21250	Implantat-kit – Neoss ProActive® Ø6.0×9mm	6.0mm	4.3mm
21251	Implantat-kit – Neoss ProActive® Ø6.0×11mm		4.3mm

Neoss ProActive® sinusimplantat

Art. Nr.	Benämning	A
21211	Implantat-kit – Neoss ProActive® Ø6.5×7mm	
21212	Implantat-kit – Neoss ProActive® Ø6.5×9mm	6.7mm
21213	Implantat-kit – Neoss ProActive® Ø6.5×11mm	



SP = Standard Plattform
Ø3.5 – 6.5 Implantat

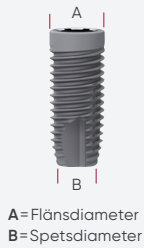

A = Flänsdiameter
B = Spetsdiameter

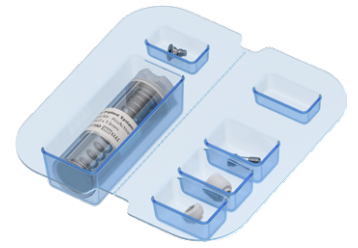
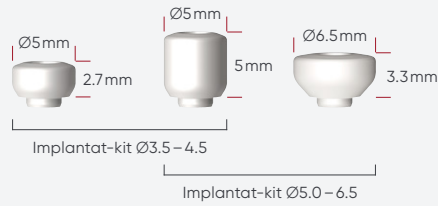

Neoss Implantat-kit

Kitet innehåller implantat, täckskruv, läkdistan-
(Ø5.0 – 6.5 kit innehåller en bredare variant) av
PEEK i två storlekar och en läkdistansskruv.

Neoss ProActive® Straight implantat

Art. Nr.	Benämning	A	B
21181	Implantat-kit – Neoss ProActive® Straight Ø3.5×7 mm		
21182	Implantat-kit – Neoss ProActive® Straight Ø3.5×9 mm		
21183	Implantat-kit – Neoss ProActive® Straight Ø3.5×11 mm	4.0 mm	2.4 mm
21184	Implantat-kit – Neoss ProActive® Straight Ø3.5×13 mm		
21185	Implantat-kit – Neoss ProActive® Straight Ø3.5×15 mm		
21186	Implantat-kit – Neoss ProActive® Straight Ø3.5×17 mm		
21187	Implantat-kit – Neoss ProActive® Straight Ø4.0×7 mm		
21188	Implantat-kit – Neoss ProActive® Straight Ø4.0×9 mm		
21189	Implantat-kit – Neoss ProActive® Straight Ø4.0×11 mm	4.0 mm	2.8 mm
21190	Implantat-kit – Neoss ProActive® Straight Ø4.0×13 mm		
21191	Implantat-kit – Neoss ProActive® Straight Ø4.0×15 mm		
21192	Implantat-kit – Neoss ProActive® Straight Ø4.0×17 mm		
21193	Implantat-kit – Neoss ProActive® Straight Ø4.5×7 mm		
21194	Implantat-kit – Neoss ProActive® Straight Ø4.5×9 mm		
21195	Implantat-kit – Neoss ProActive® Straight Ø4.5×11 mm	4.5 mm	3.2 mm
21196	Implantat-kit – Neoss ProActive® Straight Ø4.5×13 mm		
21197	Implantat-kit – Neoss ProActive® Straight Ø4.5×15 mm		
21198	Implantat-kit – Neoss ProActive® Straight Ø4.5×17 mm		
21199	Implantat-kit – Neoss ProActive® Straight Ø5.0×7 mm		
21200	Implantat-kit – Neoss ProActive® Straight Ø5.0×9 mm		
21201	Implantat-kit – Neoss ProActive® Straight Ø5.0×11 mm	5.0 mm	3.7 mm
21202	Implantat-kit – Neoss ProActive® Straight Ø5.0×13 mm		
21203	Implantat-kit – Neoss ProActive® Straight Ø5.0×15 mm		
21205	Implantat-kit – Neoss ProActive® Straight Ø5.5×7 mm		
21206	Implantat-kit – Neoss ProActive® Straight Ø5.5×9 mm		
21207	Implantat-kit – Neoss ProActive® Straight Ø5.5×11 mm	5.5 mm	4.2 mm
21208	Implantat-kit – Neoss ProActive® Straight Ø5.5×13 mm		



ProActive Straight Ø3.5



ProActive Straight Ø4.0



ProActive Straight Ø4.5



ProActive Straight Ø5.0



ProActive Straight Ø5.5

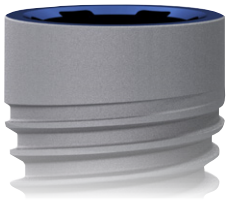

Neoss ProActive® NP Ø3.25 Implantat

Neoss smala implantat har en diameter på 3.25 mm och en protetisk plattform på 3.5 mm. Väsentliga komponenter och etiketter för NP är färgkodade med blått.

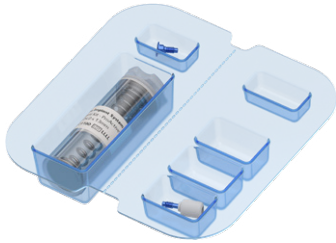

Neoss Implantat-kit

NP Ø3.25 Implantat-kit innehåller implantat, täckskruv och läkdistan (5 mm) med skruv.

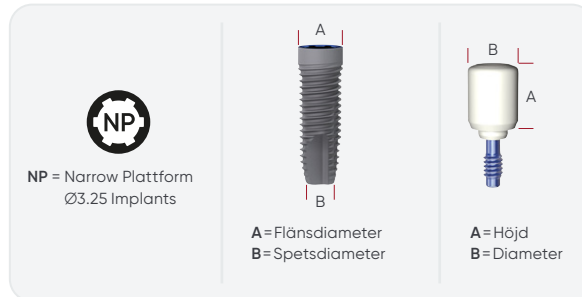

ProActive Straight NP Ø3.25

Neoss ProActive® Straight NP Ø3.25 implantat

Art. Nr.	Benämning	A	B
21176	Implantat-kit – Neoss ProActive® Straight, NP Ø3.25×9 mm		
21177	Implantat-kit – Neoss ProActive® Straight, NP Ø3.25×11 mm	3.5 mm	2.2 mm
21178	Implantat-kit – Neoss ProActive® Straight, NP Ø3.25×13 mm		
21179	Implantat-kit – Neoss ProActive® Straight, NP Ø3.25×15 mm		



Täckskruv

Täckskruv

Art. Nr.	Benämning
31408	Cover Screw SP
31409	Cover Screw NP

Lösningar för en mängd olika *maxillofaciala* procedurer

Benersättning

THE Graft™ i ampull

Art. Nr.	Benämning	Vikt	Volym
BG-A15	THE Graft Granules 0.25 – 1.00 mm	0.15g	0.36 cc
BG-A25	THE Graft Granules 0.25 – 1.00 mm	0.25g	0.60 cc
BG-A05	THE Graft Granules 0.25 – 1.00 mm	0.50g	1.20 cc
BG-A10	THE Graft Granules 0.25 – 1.00 mm	1.00g	2.40 cc
BG-A20	THE Graft Granules 0.25 – 1.00 mm	2.00g	4.80 cc
BG-B05	THE Graft Granules 1.00 – 2.00 mm	0.50g	1.80 cc
BG-B10	THE Graft Granules 1.00 – 2.00 mm	1.00g	3.60 cc



THE Graft™ i ampull

THE Graft™ i spruta

Art. Nr.	Benämning	Vikt	Volym
TG-AS25	THE Graft Syringe 0.25 – 1.00 mm	0.10g	0.25 cc
TG-AS05	THE Graft Syringe 0.25 – 1.00 mm	0.21g	0.50 cc
TG-AS10	THE Graft Syringe 0.25 – 1.00 mm	0.42g	1.00 cc
TG-BS25	THE Graft Syringe 1.00 – 2.00 mm	0.07g	0.25 cc
TG-BS05	THE Graft Syringe 1.00 – 2.00 mm	0.14g	0.50 cc
TG-BS10	THE Graft Syringe 1.00 – 2.00 mm	0.28g	1.00 cc



THE Graft™ i spruta

THE Graft™ i block

Art. Nr.	Benämning	Vikt	Volym
TCB-01	THE Graft Collagen Block	0.15g	7×7×7 mm
TCB-02	THE Graft Collagen Block	0.3g	8×9×10 mm
TCB-03	THE Graft Collagen Block	0.6g	10×11×12 mm



THE Graft™ i block

Resorberbara membran

Kollagen

Art. Nr.	Benämning	A	B
64050	NeoGen® Collagen Membrane Flex S	20 mm	15 mm
64051	NeoGen® Collagen Membrane Flex M	30 mm	20 mm
64052	NeoGen® Collagen Membrane Flex L <i>NeoGen® Kollagen-membran Flex resorberas inom 3–4 månader</i>	40 mm	30 mm
64055	NeoGen® Collagen Membrane Firm S	20 mm	15 mm
64056	NeoGen® Collagen Membrane Firm M	30 mm	20 mm
64057	NeoGen® Collagen Membrane Firm L <i>NeoGen® Kollagen-membran Firm resorberas inom 6–9 månader</i>	40 mm	30 mm



Kollagen-membran Flex

Kollagen-membran Firm

Sårbehandling

Art. Nr.	Benämning	A	B
64060	NeoGen® Collagen Wound Dressing Tape (<i>tjocklek 1 mm</i>)	75 mm	25 mm
64061	NeoGen® Collagen Wound Dressing Foam (<i>tjocklek 3 mm</i>)	40 mm	20 mm
64062	NeoGen® Collagen Wound Dressing Plug	20 mm	10 mm



Sårbehandling

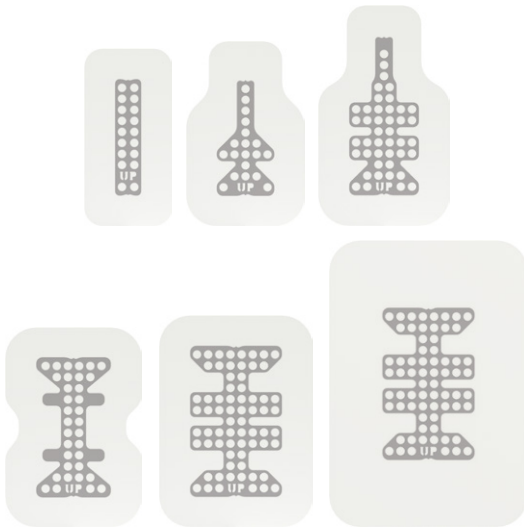
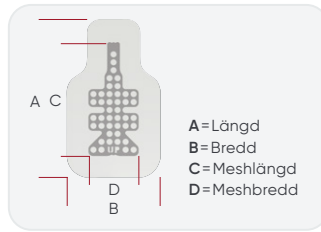

Ti-förstärkta membran

Icke resorberbara membran

Titanförstärkta PTFE-membran

Art. Nr.	Benämning	A	B	C	D
64010	NeoGen® PTFE Ti-Reinforced Membrane – S I (Small Interproximal)	29mm	14mm	19mm	4mm
64011	NeoGen® PTFE Ti-Reinforced Membrane – M I (Medium Interproximal)	30mm	19mm	19mm	9mm
64012	NeoGen® PTFE Ti-Reinforced Membrane – L I (Large Interproximal)	36mm	21mm	26mm	11mm
64013	NeoGen® PTFE Ti-Reinforced Membrane – M (Medium)	32mm	22mm	23mm	12mm
64014	NeoGen® PTFE Ti-Reinforced Membrane – L (Large)	34mm	25mm	24mm	25mm
64015	NeoGen® PTFE Ti-Reinforced Membrane – XL (Extra Large)	46mm	32mm	24mm	15mm

NeoGen® Cape

Alla NeoGen® Cape Spacer inkluderar en NeoGen® Cape Screw

Art. No. Description

64040	NeoGen® Cape PTFE Membrane – M
64041	NeoGen® Cape PTFE Membrane – L
64080	NeoGen® Cape Spacer 0.7 mm, Neoss SP
64081	NeoGen® Cape Spacer 1.5 mm, Neoss SP
64082	NeoGen® Cape Spacer 0.7 mm, Neoss NP
64083	NeoGen® Cape Spacer 1.5 mm, Neoss NP



NeoGen® Cape



NeoGen® Cape Spacer



NeoGen® Cape Screw



Icke förstärkta membran

Icke förstärkta PTFE-membran

Art. Nr.	Benämning	A	B
64019	NeoGen® PTFE Non-Reinforced Membrane 18×12 mm	18mm	12mm
64020	NeoGen® PTFE Non-Reinforced Membrane 29×14 mm	29mm	14mm
64021	NeoGen® PTFE Non-Reinforced Membrane 34×25 mm	34mm	25mm

Fixeringskit

Art. Nr. Benämning

64031	Tack Positioning Instrument
64033	Tack Mallet
64034	Tack and Screw Cassette
64036	Membrane Tack 3 mm – 10 st
64037	Membrane Screw 3 mm – 10 st



Stiftplacerare



Stifthammare



Stift- och skruv-kassett



Membran-stift



Membran-skruv

Suturer

Biotex®

Art. Nr.	Benämning
BT3016	USP 3 – 0.16 mm, 3/8 omvänt skärande nål 45 cm
BT3019	USP 3 – 0.19 mm, 3/8 omvänt skärande nål 45 cm
BT4013	USP 4 – 0.13 mm, 3/8 omvänt skärande nål 45 cm
BT4016	USP 4 – 0.16 mm, 3/8 omvänt skärande nål 45 cm
BT4019	USP 4 – 0.19 mm, 3/8 omvänt skärande nål 45 cm
BT5013	USP 5 – 0.13 mm, 3/8 omvänt skärande nål 45 cm
BT5016	USP 5 – 0.16 mm, 3/8 omvänt skärande nål 45 cm
BTP401	USP 4 – 0.13 mm, 1/2 spetsig konisk nål 45 cm



Biotex® Suturer

Neoss PTFE

Art. Nr.	Benämning
32.Z4401.00	Neoss PTFE Suture 60 cm 4/0 – omvänt skärande 16 mm 3/8 (12 st)
32.Z4408.00	Neoss PTFE Suture 60 cm 6/0 – omvänt skärande 12 mm 3/8 (12 st)



PTFE-suturer

Nya möjligheter för ditt digitala arbetsflöde

Digitala bibliotek hittar du på <https://www.neoss.com/sv/cad-libraries>



NeoScan

NeoScan

Art. Nr. Benämning

91000	NeoScan™ 1000 Intraoral Scanner <i>Inkluderar handtag, 4 spetsar (2×S, 2×L), hållare, manualer, väska. Utökade garantier finns att köpa</i>
91012	NeoScan™ 1000 – Tip L TP102N (2 st) <i>Inkluderar 2 st spetsar L</i>
91013	NeoScan™ 1000 – Tip S TP103N (2 st) <i>Inkluderar 2 st spetsar S</i>
91022	Vagn till intraoral scanner
91024	NeoScan™ 1000 – Förlängning av garanti – 1 år (Totalt 3 år)
91026	NeoScan™ 1000 – Förlängning av garanti – 2 år (Totalt 4 år)
91027	NeoScan™ 1000 – Förlängning av garanti – 3 år (Totalt 5 år)

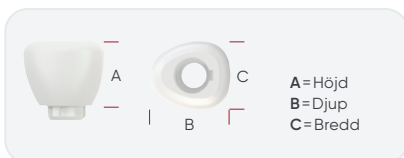

A=Höjd
B=Djup
C=Bredd



Estetisk läkdistsans med ScanPeg



Estetisk läkdistsans

Digitala avtryck

Estetisk läkdistsans med ScanPeg

Alla Estetiska läkdistsanser inkluderar titanskruv och en ScanPeg

Art. Nr. Benämning

Art. Nr.	Benämning	A	B	C
31360	Esthetic Healing Abutment with ScanPeg – Bred incisiv	5mm	5.7mm	6.1mm
31361	Esthetic Healing Abutment with ScanPeg – Smal incisiv		5.2mm	5mm
31362	Esthetic Healing Abutment with ScanPeg – Hörntand		6.3mm	5.4mm
31363	Esthetic Healing Abutment with ScanPeg – Premolar		6.8mm	5.8mm
31364	Esthetic Healing Abutment with ScanPeg – Molar		7.8mm	7.3mm

ScanPeg

Art. Nr. Benämning

Även Estetisk läkdistsans med ScanPeg kan användas för digitala avtryck

31365	ScanPeg – 5 st <i>Används endast med Estetisk läkdistsans</i>
-------	--



ScanPeg



Scan Body

Scan Body

Art. Nr. Benämning

90181	Scan Body Neoss® SP (IO 1A-A)
90182	Scan Body Neoss® NP (IO 1A-B)
90183	Scan Body Neoss® Access (IO 1B-A)

Analog

Art. Nr.	Benämning
90190	Analog for Printed Model Neoss® SP
90191	Analog for Printed Model Neoss® NP
90192	Analog for Printed Model Neoss® Access
PMA-AIT-1	Elos Accurate® Analog Pliers
PMA-AIP-2	Elos Accurate® Analog Insertion Pin (2 st)
PMA-AIS-5	Elos Accurate® Analog Insertion Screw (5 st)

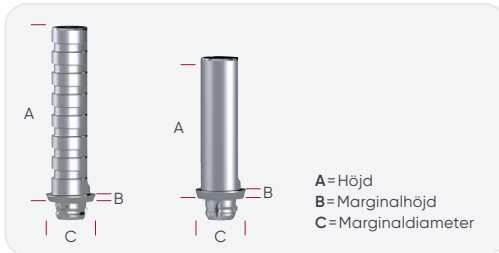

Digital protetik

Temporära distanser

Provisoriska distanser inkluderar titanskruv och rak plathätta

Art. Nr.	Benämning	A	B	C
31267	Provisional Ti Abutment Mono	15.7 mm	0.7 mm	4.5 mm
31268	Provisional Ti Abutment Multi			

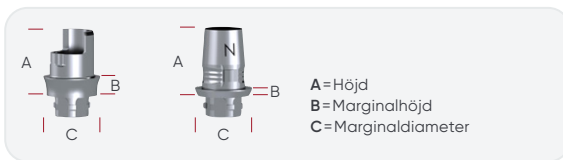
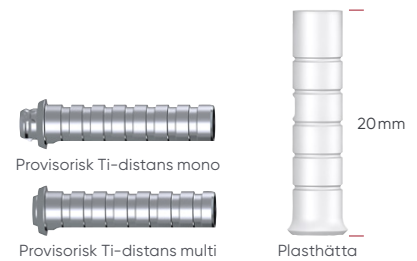

NeoBase®-distanser SSC (Straight Screw Channel)

Alla NeoBase®-distanser SSC inkluderar Neo distansskruv och Neo labbskruv

Art. Nr.	Benämning	A	B	C
31393	NeoBase® Mono SSC G0.3 mm – H3.6 mm	3.9 mm	0.3 mm	
31394	NeoBase® Mono SSC G1.5 mm – H3.6 mm	5.1 mm	1.5 mm	
31395	NeoBase® Mono SSC G0.3 mm – H5.6 mm	5.9 mm	0.3 mm	4.5 mm
31396	NeoBase® Mono SSC G1.5 mm – H5.6 mm	7.1 mm	1.5 mm	
31397	NeoBase® Multi SSC G0.3 mm – H3.6 mm	3.9 mm	0.3 mm	
31398	NeoBase® Mono SSC G0.3 mm – H3.6 mm, NP	3.9 mm		
31399	NeoBase® Mono SSC G0.3 mm – H5.6 mm, NP	5.9 mm	0.3 mm	3.8 mm
31400	NeoBase® Multi SSC G0.3 mm – H3.6 mm, NP	3.9 mm		

Inkluderar Neo distansskruv NP, Neo labbskruv NP



NeoBase®-distanser ASC (Angulated Screw Channel)

Alla NeoBase®-distanser ASC inkluderar iGO distansskruv och iGO labbskruv



NeoBase®-distanser ASC



NeoBase®-distanser ASC, NP

Art. Nr.	Benämning	A	B	C
31367	NeoBase® Mono ASC G0.3 mm – H3.6 mm	3.9 mm	0.3 mm	
31368	NeoBase® Mono ASC G1.5 mm – H3.6 mm	5.1 mm	1.5 mm	
31369	NeoBase® Mono ASC G0.3 mm – H5.6 mm	5.9 mm	0.3 mm	4.5 mm
31370	NeoBase® Mono ASC G1.5 mm – H5.6 mm	7.1 mm	1.5 mm	
31371	NeoBase® Multi ASC G0.3 mm – H3.6 mm	3.9 mm	0.3 mm	
31372	NeoBase® Mono ASC G0.3 mm – H3.6 mm, NP	3.9 mm		
31373	NeoBase® Mono ASC G0.3 mm – H5.6 mm, NP	5.9 mm	0.3 mm	3.8 mm
31374	NeoBase® Multi ASC G0.3 mm – H3.6 mm, NP	3.9 mm		

Inkluderar iGO distansskruv NP och iGO labbskruv NP

Neoss TiBase-distanser (kompatibla med Dentsply Sirona®)

TiBase-distanser inkluderar Neo distansskruv och Neo titanskruv



TiBase-distanser

Neoss ScanPost

Art. Nr.	Benämning	A	B	C
31329	Neoss TiBase N (NB B 3.4 L)			4.5 mm
31330	Neoss TiBase W (NB B 4.1 L)	5.3 mm	0.6 mm	5.0 mm
31345	Neoss TiBase, NP (FX 3.4 S)	5 mm	0.3 mm	3.9 mm

Inkluderar Neo distansskruv NP och Neo labbskruv NP

31331 Neoss ScanPost L (TiBase)
Inkluderar ScanPost med skruv

31346 Neoss ScanPost S (TiBase, NP)
Inkluderar ScanPost med skruv NP

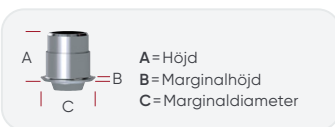

Ti NeoLink®

Ti NeoLinks inkluderar Neo distansskruv, Neo labbskruv och raka plashåttor

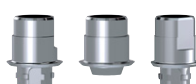

Ti NeoLink®

Art. Nr.	Benämning	A	B	C
31133	Ti NeoLink® Mono			4.5 mm
31134	Ti NeoLink® Multi	3.9 mm	0.3 mm	
31234	Ti NeoLink® Mono, NP			3.8 mm

Inkluderar distans, Neo distansskruv NP, Neo labbskruv NP och en uppsättning plashåttor

Individuella lösningar

Neoss NT Blanks

Art. Nr. Benämning

Inkluderar Neo distansskruv och Neo labbskruv

- 31375 Neoss NT Blank Ti SSC, Ø12 mm, SP – 1 st
- 31377 Neoss NT Blank Ti SSC, Ø12 mm, NP – 1 st
- 31376 Neoss NT Blank CoCr SSC, Ø12 mm, SP – 1 st
- 31378 Neoss NT Blank CoCr SSC, Ø12 mm, NP – 1 st
- 31391 Neoss NT Blank CoCr SSC, Ø16 mm, SP – 1 st

Inkluderar Neo labbskruv

- 31379 Neoss NT Blank Ti SSC, Ø12 mm, SP – 5 st
- 31381 Neoss NT Blank Ti SSC, Ø12 mm, NP – 5 st
- 31380 Neoss NT Blank CoCr SSC, Ø12 mm, SP – 5 st
- 31382 Neoss NT Blank CoCr SSC, Ø12 mm, NP – 5 st
- 31392 Neoss NT Blank CoCr SSC, Ø16 mm, SP – 5 st



NT Blank



ARC

A Neoss Group Company

Neoss individuell protetik – drivs av ARC solutions

Beställnings- och produktinformation:

Online: www.arcsolutions.se www.neoss-cadcam.de

Telefon: +46 42 301 74 40

För komplett erbjudande, besök www.arcsolutions.se

ARC Solutions är specialister på tillverkning av skräddarsydda implantatproteser. Med ett starkt fokus på kvalitet och innovativ teknik är ARC Solutions högsta målsättning att ge kunderna bästa möjliga service och leverera pålitliga produkter.

	Distans						Bro				Bar			
	Ti		CoCr		ZrO		Ti		CoCr		Ti		CoCr	
	R	V	R	V	R	V	R	V	R	V	R	V	R	V
Neoss SP	✓	✓	✓	✓	✓	✓	✓	✓	✓	✓	✓	✓	✓	✓
Neoss NP	✓	✓	✓	✓	✓	✓	✓	✓	✓	✓	✓	✓	✓	✓
Neoss Access							✓	✓	✓	✓	✓	✓	✓	✓

R=rak skruvkanal
V=vinklad skruvkanal



Individuella distanser, rak kanal SSC



Individuella distanser, vinklad kanal ASC



Zi-lösningar på TiBase, vinklad/rak kanal SSC/ASC

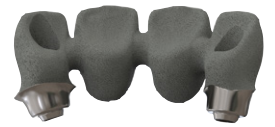

Additiva CoCr bryggor SSC/ASC



Delbroar SSC/ASC



Helbroar SSC/ASC



Individuella barer



Preci classic barer



Vertex Horix barer



Vertex barer



Dolder barer

Designkontroll med *total flexibilitet*

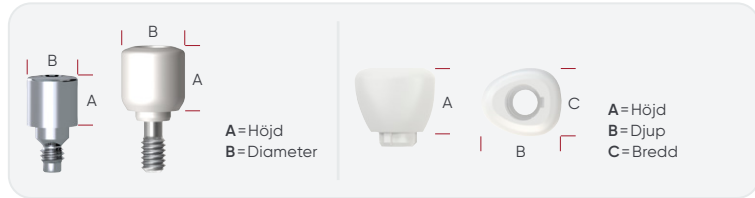

Läkdistsanser

Estetisk läkdistsans med ScanPeg

Alla Estetiska läkdistsanser inkluderar titanskruv och en ScanPeg

Art. Nr.	Benämning	A	B	C
31360	Esthetic Healing Abutment with ScanPeg – Bred incisiv	5mm	5.7mm	6.1mm
31361	Esthetic Healing Abutment with ScanPeg – Smal incisiv		5.2mm	5mm
31362	Esthetic Healing Abutment with ScanPeg – Hörntand		6.3mm	5.4mm
31363	Esthetic Healing Abutment with ScanPeg – Premolar		6.8mm	5.8mm
31364	Esthetic Healing Abutment with ScanPeg – Molar		7.8mm	7.3mm

Läkdistsanser

Art. Nr.	Benämning	A	B
31159	Healing Abutment Ti 2mm	2mm	4mm
31160	Healing Abutment Ti 4mm	4mm	
31161	Healing Abutment Ti 6mm	6mm	
31162	Healing Abutment Ti 8mm	8mm	
31163	Healing Abutment Ti 10mm	10mm	
31148	Healing Abutment PEEK 5mm with Screw	5mm	5mm
31320	Healing Abutment PEEK 5mm with Screw, NP		4mm
31321	Wide Healing Abutment PEEK 3.3mm with Screw	3.3mm	6.5mm
31335	Wide Healing Abutment PEEK 5mm with Screw	5mm	6.5mm
31410	Healing Abutment PEEK 2.7 mm with Screw	2.7mm	5mm

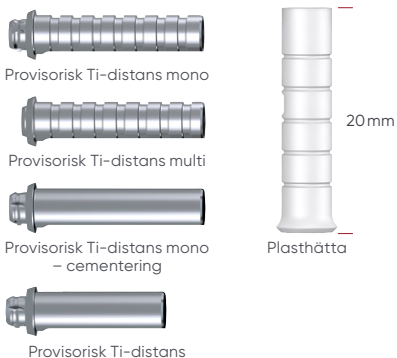

Temporär protetik

Temporära distanser

Provisoriska distanser inkluderar titanskruv och rak plathätta

Art. Nr.	Benämning	A	B	C
31267	Provisional Ti Abutment Mono	15.7mm	0.7mm	4.5mm
31268	Provisional Ti Abutment Multi			4.5mm
31332	Provisional Ti Abutment Mono – Cement Retained	10.7mm	0.7mm	3.8mm
31241	Provisional Ti Abutment, NP			3.8mm

Inkluderar Provisorisk Ti-distans och Neo labbskruv NP

Esthetic Tissue Formers

Alla Esthetic Tissue Formers inkluderar titanskruv

Art. Nr.	Benämning	A	B	C	D
31340	Esthetic Tissue Former – Bred incisiv	10 mm	4 mm	5.7 mm	6.1 mm
31341	Esthetic Tissue Former – Smal incisiv			5.2 mm	5 mm
31342	Esthetic Tissue Former – Hörntand			6.3 mm	5.3 mm
31343	Esthetic Tissue Former – Premolar			6.8 mm	5.8 mm
31344	Esthetic Tissue Former – Molar			7.8 mm	7.3 mm



Esthetic Tissue Formers

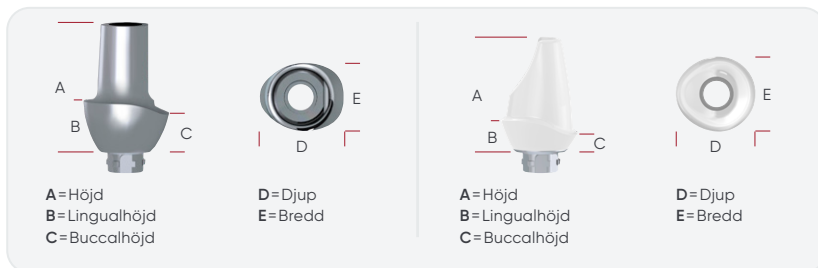

Permanenta distanser

Preparerbara titandistanser

Till Preparerbar distans medföljer Neo distansskruv och Neo labbskruv

Art. Nr.	Benämning	A	B	C	D	E
31280	Prepable Ti Abutment 1.5 mm 0° – Bred incisiv	8.5 mm	2.5 mm	1.5 mm	5.8 mm	6.5 mm
31281	Prepable Ti Abutment 1.5 mm 15° – Bred incisiv					
31282	Prepable Ti Abutment 1 mm 0° – Smal incisiv	8 mm	2 mm	1 mm	5 mm	5.1 mm
31283	Prepable Ti Abutment 1 mm 15° – Smal incisiv					
31284	Prepable Ti Abutment 3 mm 0° – Smal incisiv	10 mm	4 mm	3 mm	5.1 mm	5.1 mm
31285	Prepable Ti Abutment 3 mm 15° – Smal incisiv					
31286	Prepable Ti Abutment 3 mm 0° – Hörntand	10 mm	4 mm	3 mm	6.7 mm	5.4 mm
31305	Prepable Ti Abutment 1.5 mm 0° – Premolar	7 mm	2 mm	1.5 mm	6.9 mm	5.7 mm
31287	Prepable Ti Abutment 3 mm 0° – Premolar	9 mm	3 mm	3 mm	6.9 mm	5.7 mm
31306	Prepable Ti Abutment 1.5 mm 0° – Molar	7 mm	2 mm	1.5 mm	7.8 mm	7.1 mm
31288	Prepable Ti Abutment 3 mm 0° – Molar	9 mm	3 mm	3 mm	7.8 mm	7.1 mm
31201	Prepable Ti Abutment 1 mm 0°, NP	8 mm	2 mm	1 mm	4 mm	
31202	Prepable Ti Abutment 1 mm 15°, NP					



Preparerbara titandistanser, alternativa mjukvävnadsformer

Art. Nr.	Benämning	A	B	C	D	E
31317	Prepable Ti Abutment 2 mm 0° – Bred emergence profile <i>Inkluderar Neo distansskruv, Neo labbskruv, särskild täckskruv och särskild läkdistsans i PEEK med skruv. Kompatibel med implantatdiameter Ø5.0–6.5mm</i>	9 mm	2 mm	2 mm	7.9 mm	7.1 mm
31318	Prepable Ti Abutment 1.5 mm 0° – Smal emergence profile	8.5 mm	2 mm	1.5 mm	4.4 mm	4.5 mm
31319	Prepable Ti Abutment 1.5 mm 15° – Smal emergence profile <i>31318 och 31319 inkluderar Neo distansskruv och Neo labbskruv</i>					

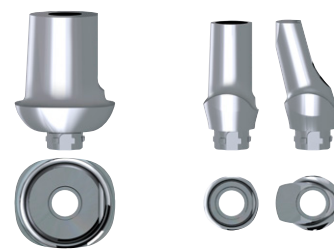



Zirconia-distanser

Zirconia-distanser

Zirconia-distanser inkluderar Zirconia-hätta Ti NeoLink® Mono, Neo distansskruv och Neo labbskruv

Art. Nr.	Benämning	A	B	C	D	E
31290	Zirconia Abutment – Bred incisiv	9mm	2.5mm	1.5mm	5.8mm	6.4mm
31291	Zirconia Abutment – Smal incisiv				5.4mm	5.1mm
31292	Zirconia Abutment – Hörntand				6.2mm	5.8mm
31293	Zirconia Abutment – Premolar		2mm	2mm	6.4mm	5.5mm
31294	Zirconia Abutment – Molar		7.2mm	6.7mm		

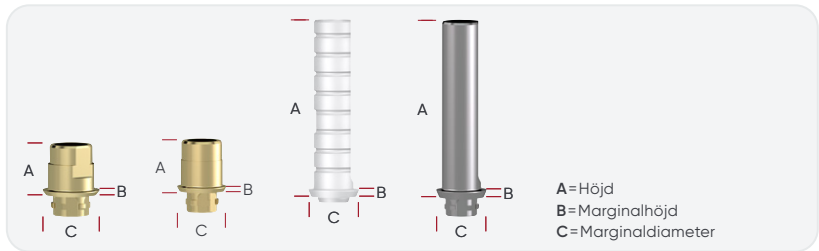

Permanent protetik – gjutning

Gold NeoLink® (för direkt gjutning)

Gold NeoLinks inkluderar Neo distansskruv, Neo labbskruv och raka plashätter



Gold NeoLink®

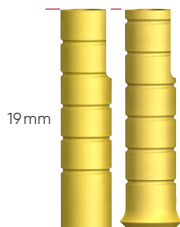

19mm

Plashätter

Art. Nr.	Benämning	A	B	C
31102	Gold NeoLink® Mono	4.0mm	0.4mm	4.5mm
31103	Gold NeoLink® Multi			3.8mm
31199	Gold NeoLink® Mono, NP <i>Inkluderar distans, Neo distansskruv NP, Neo labbskruv NP och en uppsättning plashätter</i>			

CoCr-distanser (för indirekt gjutning)

CoCr Abutments inkluderar Neo distansskruv, Neo labbskruv och rak plashätta



CoCr-distans mono



CoCr-distans multi

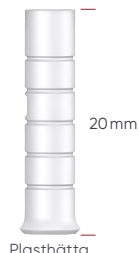

20mm

Plashätta



Urbränningsdistans mono



Urbränningsdistans multi



Access urbränningsdistans multi

Art. Nr.	Benämning	A	B	C
31269	CoCr Abutment Mono	15.7mm	0.7mm	4.5mm
31260	CoCr Abutment Multi			

Distanser för urbränning (för direkt gjutning)

31333, 31157 och 31266 inkluderar rak plashätta



NeoLink® multi för utbränning

NeoLink® plashätter

Art. Nr.	Benämning	A	B	C
31333	Burnout Abutment Mono – 2 st	15.7mm	0.7mm	4.5mm
31157	Burnout Abutment Multi – 2 st			3.8mm
31266	Access Burnout Abutment Multi – 2 st			
31255	Burnout NeoLink® Multi Ø3.25 – 2 st <i>Inkluderar en uppsättning plashätter</i>	4.3mm		

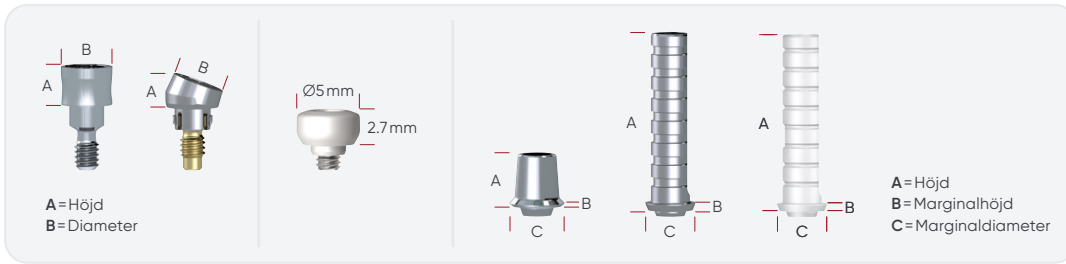

För skruvretinerade broar

Access-distanser (raka och vinklade skruvkanaler)

Art. Nr. Benämning

A B C

Access-distans inkluderar distans, förmonterad hållare och en läkdistsans

31238	Access Abutment 1.5 mm	1.5 mm		4 mm
31215	Access Abutment 3.0 mm	3 mm		
31216	Access Abutment 4.0 mm	4 mm		
31218	Access Abutment 6.0 mm	6 mm		
31219	Access Abutment 10° 2.6 mm	2.6 mm		4 mm
31243	Access Abutment 10° 4.6 mm	4.6 mm		
31221	Access Abutment 20° 2.6 mm	2.6 mm		
31244	Access Abutment 20° 4.6 mm	4.6 mm		
31223	Access Abutment 30° 2.9 mm	2.9 mm		
31245	Access Abutment 30° 4.9 mm	4.9 mm		
31225	Access Impression Coping 8 mm and Replica <i>Inkluderar avtryckstopp, styrpinne, distansreplika, förlängningscylinder för öppen sked och plasthätta för sluten sked</i>			
31366	Access Impression Coping 13 mm and Replica			
90183	Scan Body Neoss® Access (IO 1B-A)			
31226	Access Ti NeoLink® Multi	4.3 mm	0.3 mm	4.5 mm
31227	Access Gold NeoLink® Multi <i>31226 och 31227 inkluderar NeoLink®, broskruv, labbskruv och en prefabricerad plasthätta</i>	4.7 mm	0.7 mm	4.5 mm



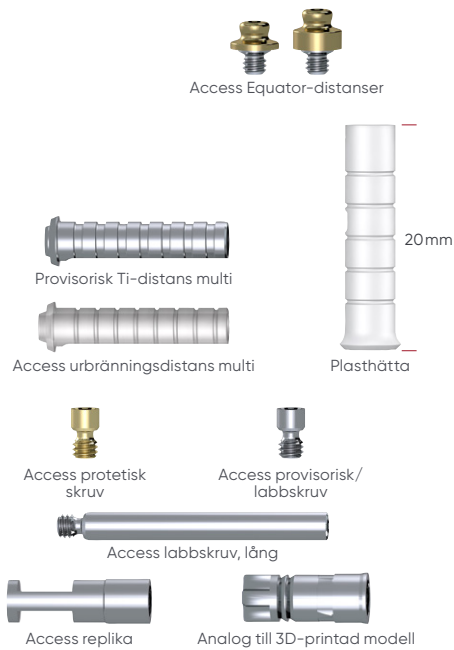

Art. Nr.	Benämning	A	B	C
90207	Access Equator Abutment Kit 0.5 mm			
90208	Access Equator Abutment Kit 1.5 mm			
31301	Access Provisional Ti Abutment Multi <i>Innehåller provisorisk/labbskruv och rak plathätta</i>	15.7 mm	0.7 mm	4.5 mm
31266	Access Burnout Abutment Multi – 2 st <i>Innehåller rak plathätta</i>			
31229	Access Neo Prosthetic Screw – 1 st			
31257	Access Neo Provisional/Laboratory Screw – 5 st			
31265	Access Neo Laboratory Screw Long – 5 st			
31231	Access Replica – 5 st			
90192	Analog for Printed Model Neoss® Access			

Täckprotes-distanser

Equator-distanser

Alla kit inkluderar Equator-distans, matrishållare för arbetsmatrix, skyddsdisk samt retentionselement; standard, stark, lätt, extra lätt



Art. Nr.	Benämning
90201	Neoss Equator Abutment Kit 1 mm
90202	Neoss Equator Abutment Kit 2 mm
90242	Neoss Equator Abutment Kit 2 mm, NP
90203	Neoss Equator Abutment Kit 3 mm
90243	Neoss Equator Abutment Kit 3 mm, NP
90204	Neoss Equator Abutment Kit 4 mm
90244	Neoss Equator Abutment Kit 4 mm, NP
90205	Neoss Equator Abutment Kit 5 mm
90206	Neoss Equator Abutment Kit 6 mm
90207	Access Equator Abutment Kit 0.5 mm
90208	Access Equator Abutment Kit 1.5 mm
90210	Neoss Equator Cap and Housing Kit
90215	Neoss Equator Cap and Housing Kit – Extended Divergence
90211	Neoss Equator Cap Standard Retention, White – 2 st
90212	Neoss Equator Cap Strong Retention, Violet – 2 st
90213	Neoss Equator Cap Soft Retention, Pink – 2 st
90214	Neoss Equator Cap Extra Soft Retention, Yellow – 2 st
90220	Neoss Equator Impression Coping & Replica – 2 sets
90222	Neoss Equator Protector Disk – 10 st
90232	Neoss Equator Cap Tool

Bar-distanser

Art. Nr. Benämning

31168	Bar Abutment Gold <i>Innehåller distans, Neo distansskruv och Neo labbskruv</i>
31261	Bar Abutment Ti 14 mm <i>Inkluderar Neoss distansskruv och labbskruv</i>

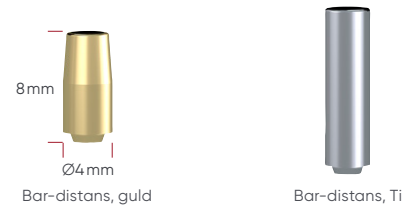

Avtryckstoppar & analoger

Avtryckstoppar

Art. Nr. Benämning

31170	Impression Coping 8 mm and Replica
31145	Impression Coping 11 mm and Replica
31183	Impression Coping 18 mm and Replica <i>31170, 31145 och 31183 inkluderar avtryckstopp, styrpinne, implantatreplika, förlängningscylinder för öppen sked och plashätta för sluten sked</i>
31302	Impression Coping Open Tray 8 mm and Replica
31185	Impression Coping Open Tray 13 mm and Replica <i>31302 och 31185 inkluderar avtryckstopp, styrpinne, implantatreplika och förlängningscylinder</i>
31197	Impression Coping 11 mm and Replica, NP <i>Inkluderar avtryckstopp, styrpinne, implantatreplika, förlängningscylinder för öppen sked och plashätta för sluten sked</i>
31366	Access Impression Coping 13 mm and Replica
31186	Impression Coping Cap Closed Tray – 10 st
31262	Impression Coping Extension Tube – 20 st

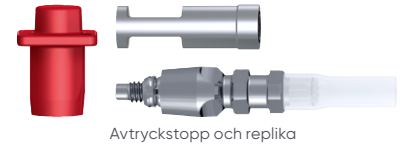

Avtryckstopp och replika

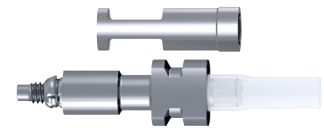

Avtryckstopp öppen sked och replika

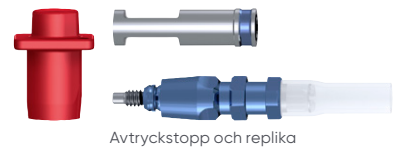

Avtryckstopp och replika



Access avtryckstopp och replika



Avtryckshätta

Förlängningsrör

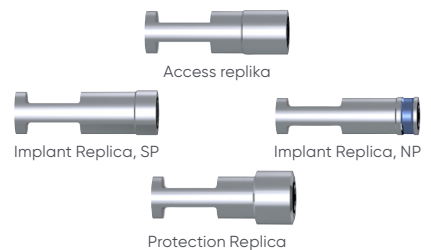

Access replika

Implant Replica, SP

Implant Replica, NP

Protection Replica

Analoger

Art. Nr. Benämning

31231	Access Replica – 5 st
31146	Implant Replica – 5 st
31198	Implant Replica, NP – 5 st
31304	Implant Replica, NP – 1 st
31166	Protection Replica – 1 st



Skrubar

Art. Nr. Benämning

31258	Neo Abutment Screw, SP – 1st
31259	Neo Abutment Screw, SP – 5st
31240	Neo Abutment Screw Ti, NP – 1st
31149	Neo Laboratory Screw, SP – 5st
31239	Neo Laboratory Screw, NP – 1st
31303	Neo Laboratory Screw Long, SP – 5st
31347	iGO Abutment Screw, SP – 1st
31349	iGO Abutment Screw, NP – 1st
31348	Access iGO Prosthetic Screw – 1st
31350	iGO Laboratory Screw, SP – 1st
31352	iGO Laboratory Screw, NP – 1st
31351	Access iGO Laboratory Screw – 1st
31229	Access Neo Prosthetic Screw – 1st
31257	Access Neo Provisional/Laboratory Screw – 5st
31265	Access Neo Laboratory Screw Long – 5st

Neo = Neoss standard skruv/skruvmejsel



Instrumenten *du behöver*

Borr

Art. Nr. Benämning

41153	Round Bur Ø1.8mm	
41152	Lance Drill Ø1.5×3/5/7mm	
41170	Pilot Drill Ø2.2/3.0mm	
41154	Twist Drill, Straight Ø2.2×7 – 17mm	
41156	Twist Drill, Straight Ø2.85×7 – 17mm	
41157	Twist Drill, Straight Ø3.0×7 – 17mm	
41158	Twist Drill, Straight Ø3.2×7 – 17mm	
41159	Twist Drill, Straight Ø3.4×7 – 17mm	
41160	Twist Drill, Straight Ø3.6×7 – 17mm	
41161	Twist Drill, Straight Ø3.9×7 – 17mm	
41162	Twist Drill, Straight Ø4.1×7 – 17mm	
41163	Twist Drill, Straight Ø4.4×7 – 17mm	
41164	Twist Drill, Straight Ø4.6×7 – 17mm	
41165	Twist Drill, Straight Ø4.9×7 – 17mm	
41166	Twist Drill, Straight Ø5.1×7 – 17mm	
41205	Twist Drill, Straight Ø6.0×7 – 11 (13)mm	
41193	Drill Kit, Straight Implants Ø3.5 – 5.0 <i>Innehåller spiralborr Ø2.2, 3.0, 3.4, 3.9 och 4.4</i>	
41172	Twist Drill, Tapered Ø3.0×7 – 17mm	1.9mm
41173	Twist Drill, Tapered Ø3.4×7 – 17mm	2.3mm
41174	Twist Drill, Tapered Ø3.9×7 – 17mm	2.8mm
41175	Twist Drill, Tapered Ø4.4×7 – 17mm	Ø 3.3mm
41176	Twist Drill, Tapered Ø4.9×7 – 17mm	3.8mm
41206	Twist Drill, Tapered Ø5.5×7 – 17mm	4.3mm
41204	Twist Drill, Tapered Ø5.5×7 – 11 (13)mm	4.3mm
41192	Drill Kit, Tapered Implants Ø3.5 – 5.0 <i>Innehåller spiralborr Ø2.2 S, 3.0 T, 3.4 T, 3.9 T och 4.4 T</i>	
41177	Drill Kit, Edge Implants Ø3.5 – 5.0 <i>Innehåller spiralborr Ø2.2 S, 3.0 T, 3.4 T, 3.9 T och 4.4 T</i>	
41142	Drill Stop 7mm Ø2.2, 3.0, 3.4, 3.9 and 4.4mm	
41143	Drill Stop 9mm Ø2.2, 3.0, 3.4, 3.9 and 4.4mm	
41144	Drill Stop 11mm Ø2.2, 3.0, 3.4, 3.9 and 4.4mm	
41145	Drill Stop 13mm Ø2.2, 3.0, 3.4, 3.9 and 4.4mm	
41146	Drill Stop 15mm Ø2.2, 3.0, 3.4, 3.9 and 4.4mm	
41215	Twist Drill, Straight Ø2.2×7 – 17mm	
41216	Twist Drill, Straight Ø2.85×7 – 17mm	
41217	Twist Drill, Straight Ø3.0×7 – 17mm	
41218	Twist Drill, Straight Ø3.2×7 – 17mm	
41219	Twist Drill, Straight Ø3.4×7 – 17mm	
41220	Twist Drill, Straight Ø3.6×7 – 17mm	
41221	Twist Drill, Straight Ø3.9×7 – 17mm	
41222	Twist Drill, Straight Ø4.1×7 – 17mm	
41223	Twist Drill, Straight Ø4.4×7 – 17mm	
41224	Twist Drill, Straight Ø4.6×7 – 17mm	
41225	Twist Drill, Straight Ø4.9×7 – 17mm	
41226	Twist Drill, Straight Ø5.1×7 – 17mm	



Rundborr



Lansborr



Pilotborr



Spiralborr, Straight



Spiralborr, Tapered



Borr-stopp

Engångs

Flergångs



Spiralborr, Straight - kort



Spiralborr, Tapered - kort



Försänkare



Försänkare, Straight

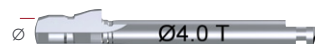

Försänkare, Tapered



Försänkare, Edge



Gängtapp

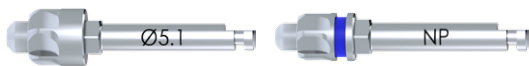

Bone Profiler



Bone Remover Cover Screw

Art. Nr. Benämning

41233	Drill Kit, Straight Implants Ø3.5 – 5.0 <i>Inkluderar spiralborr Ø2.2, 3.0, 3.4, 3.9 och 4.4</i>	
41184	Drill Kit, Straight – Short 7 – 13 mm <i>Inkluderar spiralborr Ø2.2, 3.0, 3.4, 3.9, 4.4 och 4.9</i>	
41227	Twist Drill, Tapered Ø3.0×7 – 17 mm	1.9 mm
41228	Twist Drill, Tapered Ø3.4×7 – 17 mm	2.3 mm
41229	Twist Drill, Tapered Ø3.9×7 – 17 mm	2.8 mm
41230	Twist Drill, Tapered Ø4.4×7 – 17 mm	3.3 mm
41231	Twist Drill, Tapered Ø4.9×7 – 17 mm	3.8 mm
41232	Twist Drill, Tapered Ø5.5×7 – 17 mm	4.3 mm
41235	Drill Kit, Tapered Implants Ø3.5 – 5.0 <i>Inkluderar spiralborr Ø2.2S, 3.0T, 3.4T, 3.9T och 4.4T</i>	
41191	Drill Kit Tapered – Short 7 – 13 mm <i>Inkluderar spiralborr Ø2.2S, 3.0T, 3.4T, 3.9T, 4.4T, och 4.9T</i>	
41236	Drill Kit, Edge Implants Ø3.5 – 5.0 <i>Inkluderar spiralborr Ø2.2S, 3.0T, 3.4T, 3.9T och 4.4T</i>	
41139	Countersink, Straight Ø3.25	2.7 mm
41110	Countersink, Straight Ø3.5	2.9 mm
41111	Countersink, Straight Ø4.0	3.3 mm
41112	Countersink, Straight Ø4.5	3.5 mm
41133	Countersink, Straight Ø5.0	4.3 mm
41127	Countersink, Straight Ø5.5	4.7 mm
41178	Countersink, Tapered Ø3.5	2.0 mm
41179	Countersink, Tapered Ø4.0	2.8 mm
41180	Countersink, Tapered Ø4.5	3.3 mm
41181	Countersink, Tapered Ø5.0	3.7 mm
41182	Countersink, Tapered Ø5.5	4.2 mm
41210	Countersink, Edge Ø3.5	1.8 mm
41211	Countersink, Edge Ø4.0	2.6 mm
41212	Countersink, Edge Ø4.5	3.0 mm
41213	Countersink, Edge Ø5.0	3.5 mm
41202	Countersink Ø6.0	4.8 mm
41201	Countersink Ø6.5	5.2 mm
41113	Screw Tap Ø3.5	
41114	Screw Tap Ø4.0	
41115	Screw Tap Ø4.5	
41134	Screw Tap Ø5.0	
41126	Screw Tap Ø5.5	
41140	Screw Tap Ø3.25	
41237	Bone Profiler Ø5.1 mm, SP	
41238	Bone Profiler Ø6.6 mm, SP	
41239	Bone Profiler Ø4.1 mm, NP	
41240	Bone Remover Cover Screw, SP	
41241	Bone Remover Cover Screw, NP	

Hergångs

Kit

Brickor – kirurgi och protetik

Art. Nr. Benämning

51189	Neoss Kirurgi och Protetik bricka – ProActive® Edge
51188	Neoss Kirurgi och Protetik bricka – ProActive® Tapered
51187	Neoss Kirurgi och Protetik bricka – ProActive® Straight

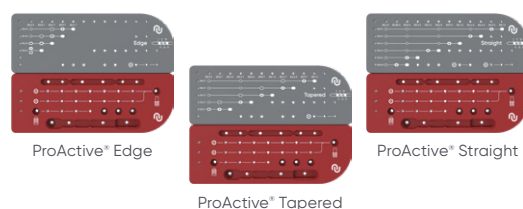

Brickor & brickor med instrument-kit

Art. Nr. Benämning

51180	Neoss Prosthetic Tray – Neo
51181	Neoss Prosthetic Instrument Kit – Neo <i>Inkluderar protetikbricka, momentdragare, skruvmejsel för vinkelstycke 22 mm och 32 mm, manuell skruvmejsel 15 mm med tillhörande handtag</i>
41151	Surgical Instrument Kit <i>Inkluderar art. nr. 41120, 51118, 51119, 51144, 51139, 51140, 51125, 51126</i>
51186	Neoss ProActive® Implant System Box
41254	Drill and Surgical Instrument Kit, Edge Implants Ø3.5 – 5.0 <i>Spiralborr för engångsbruk. Inkluderar art. nr. 41177, 41210, 41211, 41212, 41213, 41237, 41238, 41240, 41151, 41153, 41152, 41170, 51121, 51137, 51141, 51186, 51189 och 51190</i>
41253	Drill and Surgical Instrument Kit, Edge Implants Ø3.5 – 5.0 <i>Spiralborrar för flergångsbruk. Inkluderar art. nr. 41236, 41210, 41211, 41212, 41213, 41237, 41238, 41240, 41151, 41153, 41152, 41170, 51121, 51137, 51141, 51186, 51189 och 51190</i>
41252	Drill and Surgical Instrument Kit, Tapered Implants Ø3.5 – 5.0 <i>Spiralborr för engångsbruk. Inkluderar art. nr. 41192, 41158, 41160, 41162, 41164, 41178, 41179, 41180, 41181, 41151, 41153, 41152, 41170, 41237, 41238, 41240, 51121, 51137, 51141, 51186, 51188 och 51190</i>
41251	Drill and Surgical Instrument Kit, Tapered Implants Ø3.5 – 5.0 <i>Spiralborrar för flergångsbruk. Inkluderar art. nr. 41235, 41218, 41220, 41222, 41224, 41237, 41238, 41240, 41178, 41179, 41180, 41181, 41151, 41153, 41152, 41170, 51121, 51137, 51141, 51186, 51188 och 51190</i>
41248	Drill and Surgical Instrument Kit, Straight Implants Ø3.5 – 5.0 <i>Spiralborr för engångsbruk. Inkluderar art. nr. 41193, 41158, 41160, 41162, 41164, 41110, 41111, 41112, 41133, 41151, 41170, 41153, 41152, 41237, 41238, 41240, 51121, 51137, 51141, 51186, 51187 och 51190</i>
41247	Drill and Surgical Instrument Kit, Straight Implants Ø3.5 – 5.0 <i>Spiralborrar för flergångsbruk. Inkluderar art. nr. 41233, 41218, 41220, 41222, 41224, 41110, 41111, 41112, 41133, 41151, 41170, 41153, 41152, 41237, 41238, 41240, 51121, 51137, 51141, 51186, 51187 och 51190</i>
41250	Drill and Surgical Instrument Kit, Straight Implants NP Ø3.25 <i>Spiralborr för engångsbruk. Inkluderar art. nr. 41154, 41156, 41157, 41139, 51142, 51145, 41241, 41239, 41170, 41153, 41152, 51121, 51137, 41120, 51144, 51125, 51139, 51140, 51141, 51126, 51190, 51186 och 51187</i>
41249	Drill and Surgical Instrument Kit, Straight Implants NP Ø3.25 <i>Spiralborrar för flergångsbruk. Inkluderar art. nr. 41215, 41216, 41217, 41139, 51142, 51145, 41241, 41239, 41170, 41153, 41152, 51121, 51137, 41120, 51144, 51125, 51139, 51140, 51141, 51126, 51190, 51186 och 51187</i>
41256	Drill and Surgical Instrument Add-On-Kit, Straight Implant Ø3.25 <i>Spiralborr för engångsbruk. Inkluderar art. nr. 41156, 41239, 41241, 41139, 51142 och 51145</i>
41255	Drill and Surgical Instrument Add-On-Kit, Straight Implant Ø3.25 <i>Spiralborrar för flergångsbruk. Inkluderar art. nr. 41216, 41239, 41241, 41139, 51142 och 51145</i>



Neoss protetik-bricka – Neo



Neoss instrument-kit, protetik – Neo



Neoss ProActive® Implant System Box



Drill and Surgical Instrument Kit, Edge



Drill and Surgical Instrument Kit Tapered



Drill and Surgical Instrument Kit Straight



Neoss® Guide Kit



Implantat-bärare



Implantat-styrning



Implantatmejsel

Guide

Art. Nr. Benämning

51154	Neoss® Guide Kit Ø3.5 – Ø6.0 <i>(Neoss Implantat Ø3.5 – Ø6.0 mm, längd 7 – 15 mm.) Innehåller 5×Borrv, 2×Försänkare Conduits, 4×Implantat-bärare Ø5.0 S9, 2×Implantat-bärare Ø6.0 S9, 7×Borrvycklar, 3×Adapter till borrvycklar, 1×Hållare till borrvyckel. Reservdelar finns tillgängliga, kontakta din lokala säljare för mer detaljer.</i>
51173	Neoss® Guide – Implant Mount SP, Ø5.0 S9 – 2 st
51174	Neoss® Guide – Implant Mount SP, Ø6.0 S9 – 2 st
51156	Neoss® Guide – Sleeve Ø5.0 – 10 st
51157	Neoss® Guide – Sleeve Ø6.0 – 5 st
51155	Neoss® Guide – Implant Inserter, SP <i>För delvis guidad, se IFU</i>

Neoss® Guide Kit – RESERVDELAR

Art. Nr. Benämning

51160	Neoss® Guide – Drill-Hub I
51161	Neoss® Guide – Drill-Hub II
51162	Neoss® Guide – Drill-Hub III
51163	Neoss® Guide – Drill-Hub IV
51164	Neoss® Guide – Drill-Hub V
51165	Neoss® Guide – Guide Key Ø2.2/2.85
51166	Neoss® Guide – Guide Key Ø3.0/3.2
51167	Neoss® Guide – Guide Key Ø3.4/3.6
51168	Neoss® Guide – Guide Key Ø3.9/4.1
51169	Neoss® Guide – Guide Key Ø4.4/4.6
51170	Neoss® Guide – Guide Key Ø4.9/5.1
51178	Neoss® Guide – Guide Key Ø5.5
51171	Neoss® Guide – Countersink Conduit Ø5.0
51172	Neoss® Guide – Countersink Conduit Ø6.0
51176	Neoss® Guide – Guide Key Adapter – 2 st
51177	Neoss® Guide – Holder Guide Key Adapter
51158	Drill Sleeve Ø2.2 – 10 st



Borrv



Borrvyckel



Försänkare Conduit



Borrv-styrning



Adapter till borrvyckel



Hållare till borrvyckel



King Size demo-kit

Demo-kit

Art. Nr. Benämning

61150	King Size Dummy Kit <i>Inkluderar Neoss Straight, Tapered och Edge Implantat, implantatmejsel, skruvmejsel, distansskruv, NeoLink®-distans, Estetisk läkdistan med ScanPeg för smal incisiv och krona</i>
-------	--

Instrument

Art. Nr. Benämning

51137	Implant Inserter, SP 17 mm
51118	Implant Inserter, SP 22 mm
51119	Implant Inserter, SP 32 mm
51145	Implant Inserter, NP 24 mm
51142	Implant Inserter, NP 32 mm
51139	Neo Screwdriver, Machine 22 mm
51140	Neo Screwdriver, Machine 32 mm
51141	Neo Screwdriver, Manual 15 mm
51183	iGO Screwdriver, Machine 22 mm
51184	iGO Screwdriver, Machine 32 mm
51125	Direction/Depth Gauge – 4 st
41120	Drill Extender
51190	Neoss Depth Gauge Probe
51121	Ratchet
51126	Manual Handle
51191	Insertion Handle – Large
51144	Wrench Adapter
51149	Angulation Gauge, SP
90138	Adjustment Handle
41214	X-ray Planner ProActive Edge Implants
41119	X-ray Planner ProActive Straight Implants
41183	X-ray Planner ProActive Tapered Implants
41203	X-ray Planner Ø6.0 Implants
41200	X-ray Planner Ø6.5 Implants

Neo = Neoss standard skruv/skruvmejsel

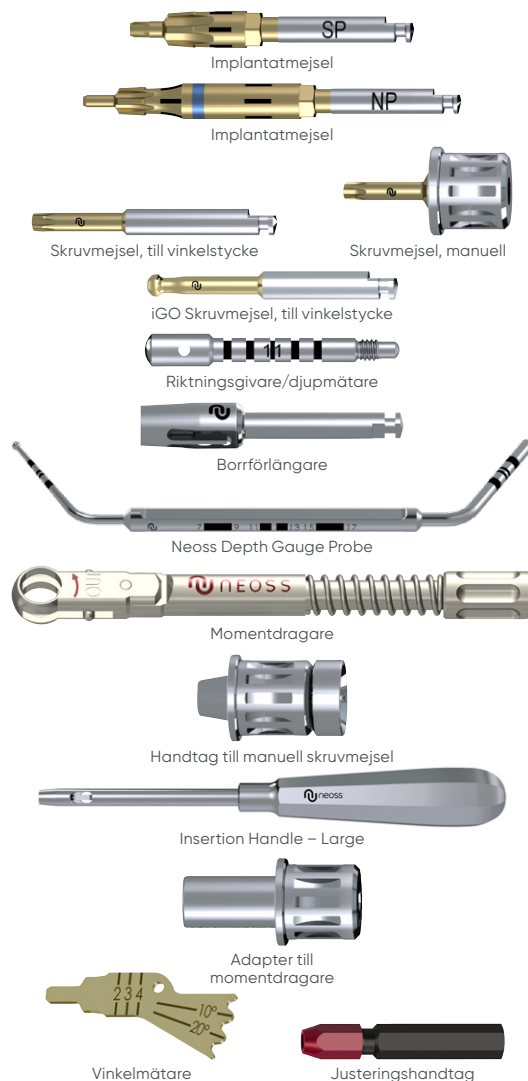

ISQ (Implant Stability Quotient)

Neoss Penguin^{RFA}

Art. Nr. Benämning

90300	Neoss Penguin ^{RFA} Instrument <i>Inkluderar Neoss Penguin^{RFA} Instrument, Neoss MultipegTM Driver, laddare och adaptrar</i>
90307	Sterile Cover Neoss Penguin ^{RFA} Instrument – 20 st
90306	Neoss Multipeg TM Driver
90310	Multipeg TM 18, Neoss SP
90311	Multipeg TM 19, Neoss NP
90312	Multipeg TM 52, Neoss Access

Multipegs för andra märken finns tillgängliga, kontakta din lokala säljare för mer detaljer.



Protetiska komponenter Standard och Narrow Plattform – översikt

Protetik – översikt, SP och NP (Ø3.25 – 6.5 implantat)



		Enhet		Retention		Implantat-plattform		Nivå		Material					Vinklad skruvkanal	Esthetiline
		Entand	Bro	Cement-retinerad	Skruv-retinerad	SP	NP	Implantat-nivå	Distans-nivå	Ti	ZrO	Gold	CoCr	Polymer		
Temporär protetik	Temporär Ti-distans	☑	☑	☑	☑	☑	☑	☑	☑	☑						
	Esthetic Tissue Former	☑		☑	☑	☑		☑					☑			☑
Permanent protetik	Prefabricerade	Preparerbar titandistans	☑		☑	☑	☑	☑	☑	☑						☑
		Ti NeoLink*	☑	☑	☑	☑	☑	☑	☑	☑						☑
		Zirconia-distans	☑		☑	☑	☑		☑			☑				☑
		Access-distans (0 – 30°)		☑		☑	☑		☑		☑					
	Digitalt	NeoBase® (SSC, ASC*)	☑	☑	☑	☑	☑	☑	☑	☑					☑	☑
		TiBase	☑		☑	☑	☑	☑	☑	☑						
		Blanks	☑		☑	☑	☑	☑	☑	☑			☑			☑
		Individuell protetik* central milling	☑	☑	☑	☑	☑	☑	☑	☑	☑		☑		☑	☑
	Gjutning	Gold NeoLink*	☑	☑		☑	☑	☑	☑	☑		☑				☑
		Burnout-distans	☑	☑	☑	☑	☑	☑	☑	☑						
CoCr-distans		☑	☑	☑	☑	☑		☑				☑				
Täck-protetis	Equator-distans		☑			☑	☑	☑	☑							
	Bar-distans		☑			☑		☑								

* Använd iGO distansskruv och skruvmejsel för vinklade skruvkanaler, finns som tillval även för raka skruvkanaler på Neoss individuellt frästa protetik.

Rekommenderade åtdragningsmoment och borrhastigheter – översikt

Neoss implantatsystem – Rekommenderade åtdragningsmoment (Ncm)

Implantat	Gängtapp	Läkning			Temporära distanser		Avtryck	Permanent protetik					
		Täckskruv	Estetisk läkdistans PEEK och Estetisk läkdistans	Läkdistans Ti	Esthetic Tissue Former	Temporär titandistans		Skruvur för avtryckshätta	Neo distansskruv	Access-distans, rak och vinklad	Neo Access protetikskruv	Equator-distans	
45 Max	40 – 45	10 Max	10 Max	10 Max	20	20	10 Max	32*	32	20		Implantat-nivå	Distans-nivå
												32	20

* 35 Ncm möjligt för fall med hög belastning

Permanent protetik med iGO skruvar		
iGO distansskruv, SP	iGO distansskruv, NP	iGO protetikskruv Access
32	20	20

Neoss implantatsystem – Rekommenderade borr- och installationshastigheter (rpm)

Borr	Gängtapp	Försänkare	Implantat	Bone Mill
800 – 2000**	20	800	20 Max	40 Max

** lågre hastighet för större borr

Symboler, namn och förkortningar



SP = Standard Plattform Ø3.5 – 6.5 implantat

NP = Narrow Plattform Ø3.25 implantat

iGO = används för iGO skruv och iGO skruvmejsel

Neo = Neoss standard skruv/skruvmejsel

SSC = Straight/rak skruvkanal

ASC = Angulated/vinklad skruvkanal

Du kan nu köpa dina produkter online!

Produkter kan också beställas online på neoss.com.

Vissa produkter är inte regulatoriskt eller kommersiellt tillgängliga för alla marknader och tillgängliga i begränsade kvantiteter. Kontakta din lokala representant för tillgänglighet och priser.

Ansvarsfrihet

Neoss produkter får endast användas enligt tillverkarens instruktioner och rekommendationer.

Användaren av Neoss produkter ska fastställa dess lämplighet för specifika patienter och indikationer.

Neoss friskriver sig från allt ansvar, uttryckt eller underförstått och har inget ansvar för någon direkt, indirekt, bestraffningsbar eller annan skada som uppstår av eller i samband med fel i den yrkesmässiga bedömningen eller praxis vid användning eller inplacering av Neoss produkter.

Produktbilder är inte skalnliga och kan vara föremål för förändringar.

Alla dimensioner är endast för identifieringsändamål.

Copyright, tillverkningsrättigheter och varumärken:

Dokument, programvara och utformning från Neoss får inte skrivas om, kopieras eller publiceras delvis eller i sin helhet utan skriftligt medgivande från Neoss Limited.

Neoss, 'N'-logotypen, NeoGen, NeoLink, NeoLoc, NeoBase och Neoss ProActive är registrerade varumärken tillhörande Neoss Group. NeoScan är ett varumärke som tillhör Neoss Group.

THE Graft™ är ett varumärke som tillhör Purgo Biologics Inc. Biotex® är ett registrerat varumärke som tillhör Purgo Biologics Inc.

Elos Accurate är ett registrerat varumärke tillhörande Elos Medtech AB. LOCATOR® är ett registrerat varumärke som tillhör ZEST IP Holdings, LLC U.S.



Digital Simplicity

för dig och dina patienter

Om arbetsflödet i din dagliga praktik är digitalt och enkelt sparar du tid, förbättrar förutsägbarheten och får hjälp att ge patienterna de bästa funktionella och estetiska resultaten.

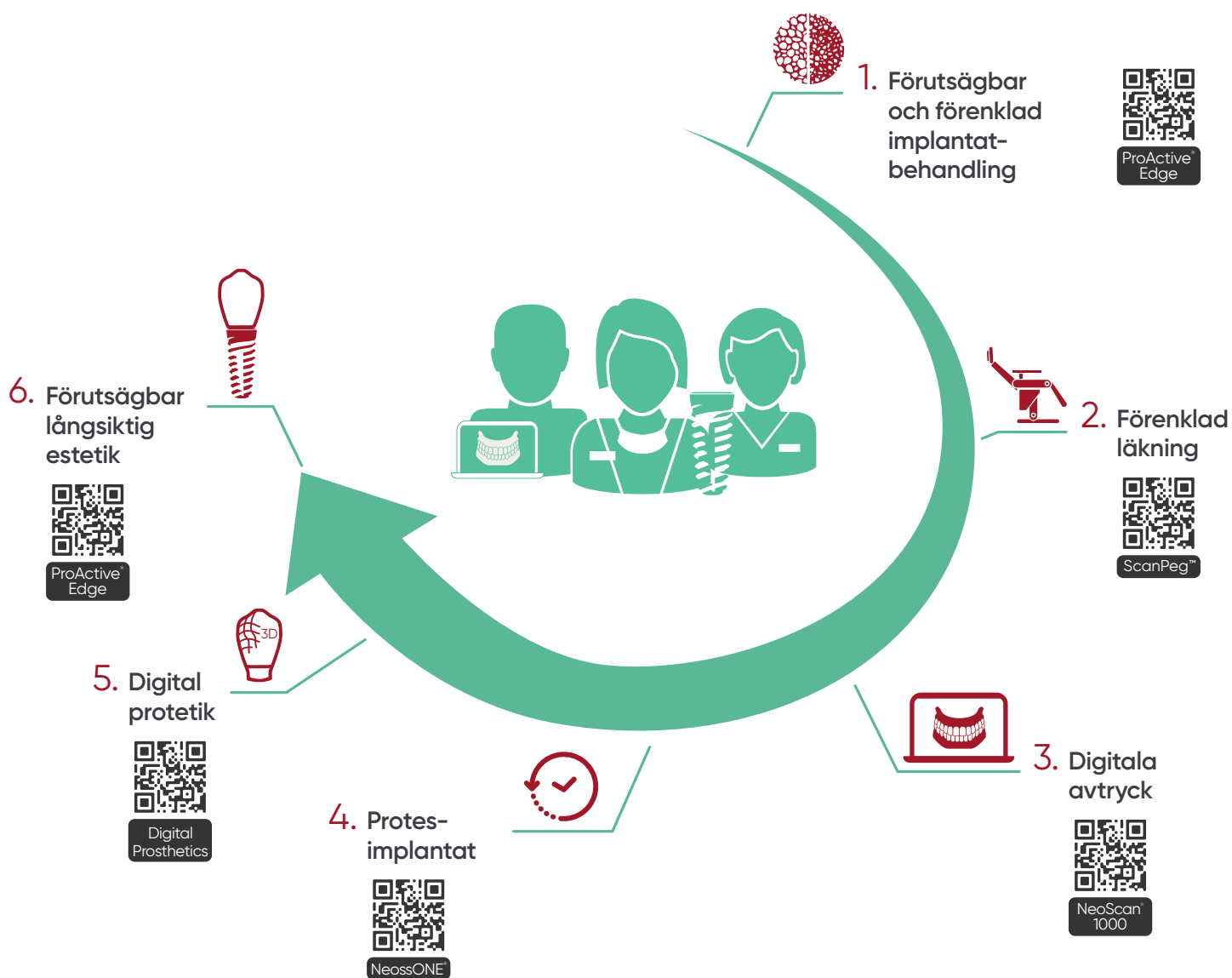

Vill du kunna sälja dina
produkter 24/7?

Köp dem online nu!



Online
Store

Anmäl dig till vår **webbutik** idag för att se till att du inte missar några bra erbjudanden.

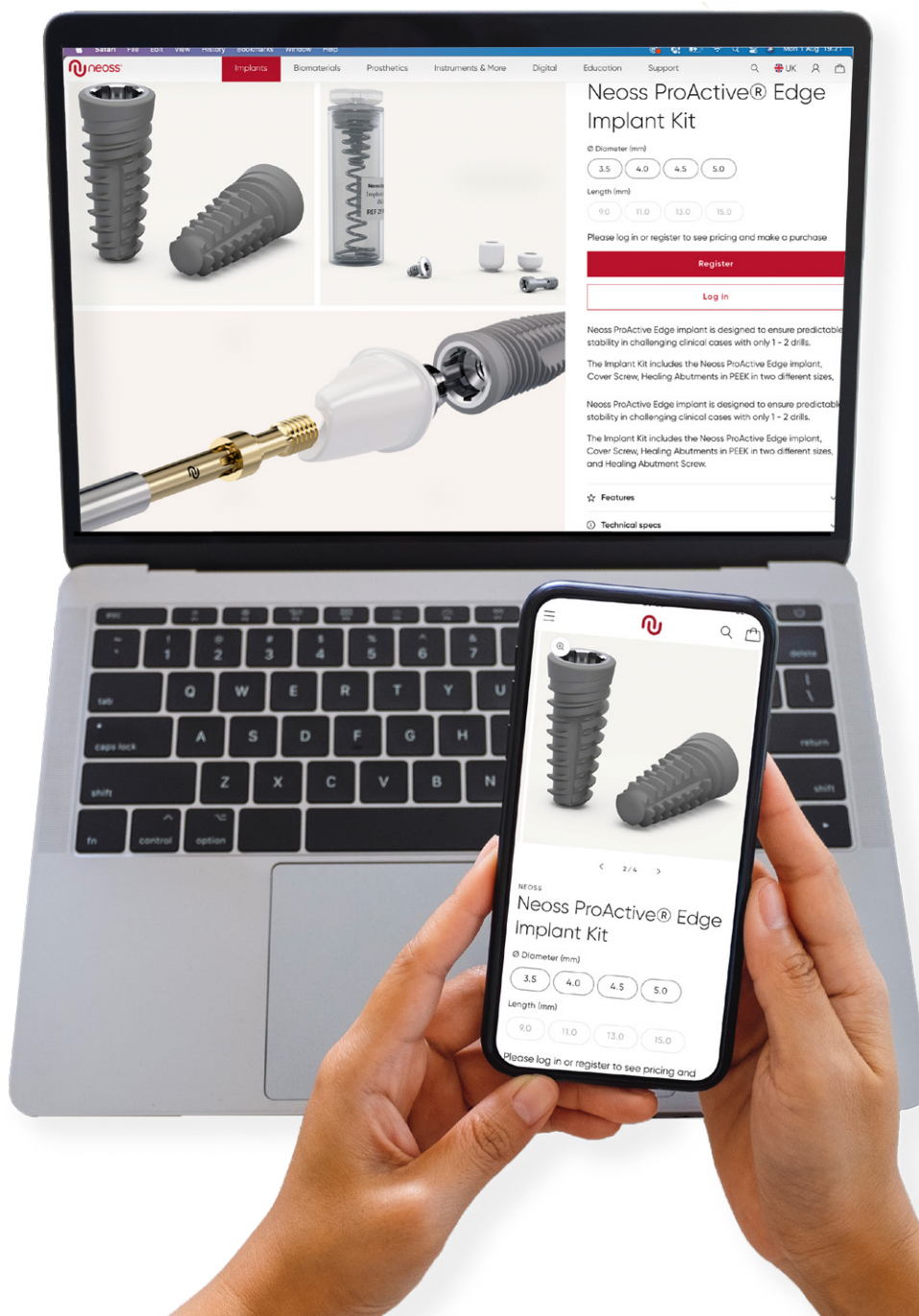

Kontakt

Våra kontor

ARC SOLUTIONS

Arc Solutions
Box 13011
SE-250 13 Helsingborg
Sweden
T: +46 42 301 74 40
E: info@arcsolutions.se

AUSTRALIEN & NYA ZEELAND

Neoss Australia Pty. Ltd
G04 Ground Floor North Tower
John Oxley Centre, 339 Coronation Drive
Milton Qld 4064, Australia
Phone: +61 7 3216 0165
E: info.au@neoss.com

EUROPEISKA DISTRIBUTÖRER

Neoss AG

The Circle 23
8058 Zurich-Airport
Switzerland
E: distributors@neoss.com

Våra distributörer

BAHRAIN

Cigalah Gulf Medical
Building 670, Block 309, Road 919
Salmaniya, Bahrain
T: +973 17232170
E: support@cgmed.com
maha@cgmed.com

EGYPTEN

Dental Future
Building No 5
Mohamed Hassanein Heikal
St. Off Abbas El Akkad Street
1st Floor Flat 3
Cairo, Egypt
T: +20 109 6696449
E: mahmod@dentalfuturekw.com

FÖRNEADE ARABEMIRATEN (ABU DHABI)

Elwan Technical Supplies
Airport Street Abu Dhabi UAE
T: +971 26393292
E: info@elwandental.com

FÖRNEADE ARABEMIRATEN (DUBAI & NORTHERN EMIRATES)

Al Zahrawi Medical Supplies
1st Floor, Ford Middle East &
Africa Building
Al Wasl Office Complex, Sheikh Zayed
Road, Downtown
Dubai, United Arab Emirates
P.O. Box: 5973
T: +971 4 262 2728
F: +971 4 262 5506
E: info@zahrawigroup.com

ITALIEN

Neoss Italia S.r.l.
Viale Certosa 138
IT-20156 Milano
T: +39 02 92952 1
E: italia@neoss.info

KINA

Neoss China
7F, #303, Songhu Rd. (KIC Build #11)
Yangpu District
Shanghai, 200433
PR China
T: +86 21 80143135
E: china@neoss.com

JAPAN

Neoss Japan Co.
Y101 Building 5F
No. 1-4 Kanda-Sudacho Chiyodaku
Tokyo 101-0041
T: 00 81 3 5289 3511
F: 00 81 3 5289 3512
E: info@neoss.co.jp

JORDANIEN

**Advanced Intelligence for Medical
Supplies & Equipment Ltd.**
Al-Swefeyyeh Paris str
Alhusainy Complex
Amman 11196
Jordan
T: +962 7 97389535
F: +962 6 5826797
E: f.khaddam@advanceime.com

KROATIEN

Medical Intertrade d.o.o
10431 Sveta Nedelja
HRVATSKA
T: +385 1 33 74 020
F: +385 1 33 36 035
E: dental@medical-intertrade.hr

KUWAIT

Dental Future Company
Salmiya Salem el Mubark street
Suhaib complex office 10
Kuwait City, Kuwait
T: +965 51155997
E: Info@dentalfuturekw.com

LIBANON

I.S. Medical Supplies Sarl
5th Floor Makoukji Bldg.
St. Antonios Street, Jdeideh Maten
Lebanon
T: +961 365 22 43
E: info.ismedical@gmail.com

MELLANÖSTERN & AFRIKA Neoss Limited (DMCC BRANCH)

Unit 1505 Fortune Tower
Cluster C – JLT
Dubai
P.O. Box 64093
United Arab Emirates
E: info.mea@neoss.com

SVERIGE, DANMARK & NORGE

Neoss Norden AB
Arvid Wallgrens backe 20
SE-413 46 Göteborg
T: +46 31 88 12 80
E: info@neoss.se

STORBRIANNIEN & IRLAND

Neoss Ltd
Windsor House, Cornwall Road
Harrogate
HG1 2PW
T: +44 1423 817 733
F: +44 1423 817 744
E: info@neoss.com

MAROCKO

Promodentaire Sarl
58. Rue Omar Al Jadidi Rabat Morocco
T: +212 623 650 826
E: promo.dentsarl@gmail.com

NEDERLÄNDERNA

Rotor, Medical Supplies B.V.
Rijksweg Zuid 51
NL-6071HV Swalmen
T: +31 46 481 12 02
F: +31 46 481 12 04
E: mail@rotor-medical.com

OMAN

Al Zahrawi Medical Supplies LLC.
Office No: 16 , Al Dar building opposite
Al Zubair automotive, street 61,
Ghala area., Muscat, Oman
P.O. Box: 1627
T: +968 24587308
F: +968 24587487
E: info.oman@zahrawigroup.com

QATAR

Al Zahrawi Medical LLC
Building No. 36, Zone No. 39
Al Sadd Area, Street No.808
Doha, Qatar, P.O. Box 63065
T: +974 4431 872
F: +974 44365216
E: info.qatar@zahrawigroup.com

SAUDIARABIEN

Tamer Group
Mohammad Ibn Abdul Wahab Street
Al Ammariya District
P.O. Box 180, Jeddah, 21411
Kingdom of Saudi Arabia
T: +966 12 643 5600
F: +966 12 642 4141
E: alaa.wanly@tamergroup.com

TYSKLAND & ÖSTERRIKE Neoss GmbH

Im Mediapark 5b
50670 Köln
T: +49 221 96980 10
F: +49 221 96980 199
E: info@neoss.de

USA

Neoss Inc.
890 Winter Street, Suite 120
Waltham, MA 02451
T: +1 866 626 3677
F: +1 818 432 2640
E: marketingusa@neoss.com

SCHWEIZ

Flexident AG
Amlehnstr. 22
CH-6010 Kriens
T: +41 41 3104020
E: contact@flexident.ch

SPANIEN

Formación, Gestión Y Rendimiento, S.L.
C. Nil Fabra 34-36., Etslo 2 B
08012, Barcelona, Spain
T: +34 931 408 770
E: info@fgdental.com

THAILAND

S.D. Tantavade Co., Ltd.
47 Samakkee 20, Samakkee Road Thasai
Muang
Nonthaburi 11000
Thailand
T: +66 2 952 4815 18
F: +66 2 952 4819
E: info@sdt1988.com

TURKIET

**Dentmark Sağlık Ürünleri
Anonim Şirketi**
Cevizli Mah. Cevizli D-100 Güney
Yanyol Cad.
No:2 Kuruş Kule Kat:3 D:52
Kartal-İstanbul PO: 34865
T: +90 216 417 4040
E: info@dentmark.com.tr

För våra leverans- och beställningsvillkor titta på din lokala webbplats
www.neoss.com

Kontakta din lokala representant för information om produkttillgänglighet.
Alla produkter är inte tillgängliga på alla marknader.