

Cleaning and maintenance of Neoss Reusable Products

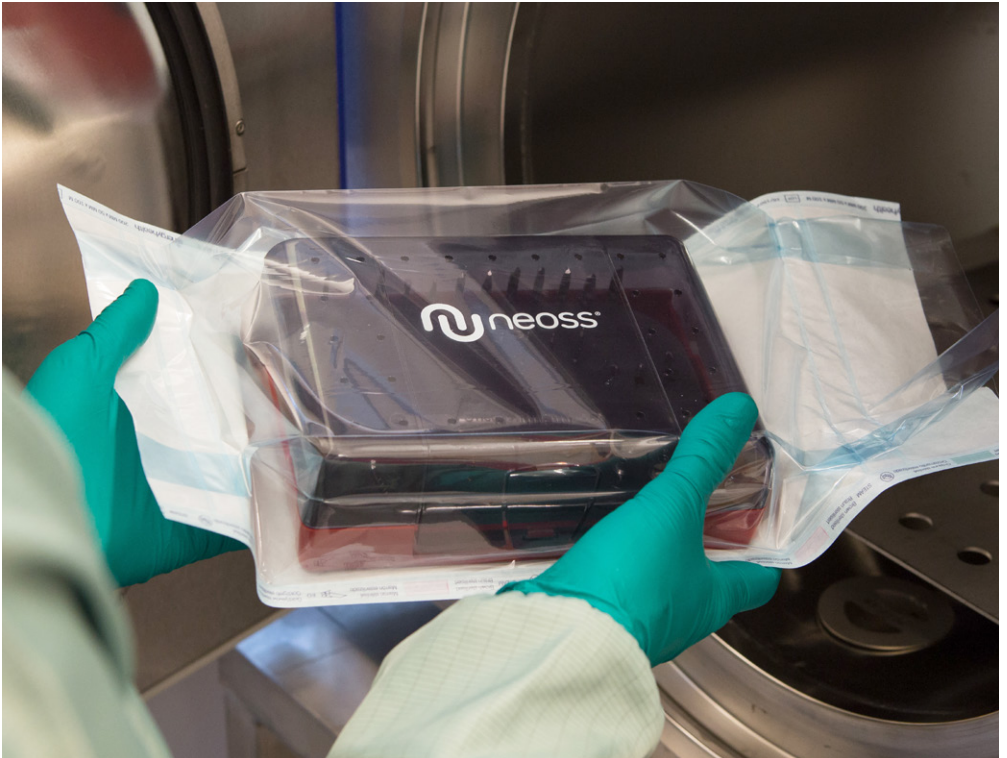

Content

1	Introduction	3
	<i>Purpose</i>	3
	<i>Target Group</i>	3
	<i>General information</i>	3
	<i>Specific information</i>	3
2	Precautions	4
3	Why all steps are important in the cleaning process	4
	<i>Cleanliness of Instruments</i>	4
	<i>Loading of Instruments and accessories</i>	4
4	Workflow	5
5	Cleaning and disinfection procedure of reusable products	6
	<i>Equipment needed</i>	6
	<i>During and directly after the clinical procedure</i>	6
	<i>Preparation for the cleaning after the clinical procedure</i>	6
	<i>Disassembling of multiple part products</i>	6
	<i>Automated cleaning, disinfection and drying including pre-cleaning</i>	6
	<i>Manual cleaning, disinfection, rinsing and drying</i>	7
	<i>Inspection</i>	7
	<i>Assembling</i>	7
6	Cleaning and disinfection of the Ratchet	8
	<i>Automated cleaning including pre-cleaning</i>	8
	<i>Manual cleaning, disinfection, rinsing and drying</i>	8
	<i>Inspection and assembling</i>	8
7	Packaging & Sterilization	9
	<i>Packaging for sterilization</i>	9
	<i>Sterilization</i>	9
8	Storage	10
9	Assembling & disassembling of Reusable products with multiple parts	10
	<i>Neoss Ratchet – disassembling, assembling and maintenance</i>	10
10	Reusable products	11
	<i>Examples of Neoss Reusable Products:</i>	11
11	Damaged products	12
12	Lifetime	14
	<i>Bone cutting instruments:</i>	14
	<i>Instruments, Scanpost, Trays:</i>	14
13	Questions & Answers	14
14	Appendix	15
	<i>Abbreviations</i>	15
	<i>Disclaimer of Liability</i>	15
	<i>References</i>	15
	<i>Customer service</i>	16

1 Introduction

Purpose

- To guide in how to prepare Neoss reusable products for use in safe clinical dental procedures with Neoss Implant System.
- To guide in how to handle Neoss reusable products after use.
- To guide in how to maintain the quality and function of reusable products.
- To guide in how to judge when a reusable product is wornout and should be disposed.

Target Group

Clinical staff taking care of the cleaning, disinfection and sterilization of medical devices in the dental clinic or similar.

General information

Neoss provides both sterile and non-sterile reusable instruments and kits to clinicians and laboratories intended for implant dentistry. Neoss reusable instruments are made from stainless steel, titanium and plastic materials that are resistant to commonly used detergents.

The cleaning, disinfection and sterilization processing of these instruments listed in chapter 10 have been tested and validated with the methods and instructions provided to the users here within. Automated cleaning is the preferred method. In the eventuality that no automated cleaning is available to the user manual cleaning can also be recommended. The recommended method for sterilization of reusable instruments is pre-vacuum steam sterilization. The four parameters of the process: steam, pressure, temperature and time has been validated for single packed instruments and system trays.

Neoss recommend the users to follow the instructions in order not to influence the product performance in a negative way. No limitations to commonly used cleaning detergent types have so far been noticed with regards to corrosion or discoloration of the instruments. There may be other equally suitable methods of processing. National cleaning and sterilization requirements shall be followed if these are different from the ones recommended here by Neoss.

It's the responsibility of the clinic to educate the staff in the recommended procedures and to ensure that appropriate equipment and cleaning agents are available in order to achieve the desired result (EN ISO 17664).

Specific information

Neoss has evaluated and described both automated and manual cleaning of the reusable products in this guideline. Automated cleaning is the preferred method.

Detergents used for the Neoss validation of manual cleaning:

- Gigazyme Plus, pH neutral
- Enzol Enzymatic Instrument Detergent, pH 7.8 – 8.8 Deacon 90, >pH13

Detergents used for the Neoss validation of the automated cleaning and disinfection:

- Getinge Clean Enzymatic Detergent, pH 7.9
- Getinge Clean Rinse Aid

If the cleaning detergents used during Neoss validation are not commercially available in your market an equivalent detergent can be used according to the manufacturers label instruction. Make sure for medical devices to use specifically formulated cleaning agents and detergents.

It is important not to exceed the manufactures of detergents recommendations regarding concentration and immersion times of the devices in order not to cause discoloring or corrosion of some materiel. Discoloring and corrosion can also occur if rinsing the devices properly after cleaning and disinfection is not performed.

The water quality is also important to emphasize. An example is hard water can contain higher contamination with microorganisms and endotoxins. This might result in staining of the products or prevent them from being effectively cleaned and disinfected.

2 Precautions

Make sure the staff is appropriately dressed with protective dress and cap, protective facemask with eye protection and puncture resistant gloves for the cleaning procedure when handling the products after use. Be careful handling the sharp drills in order not to damage the gloves.

Disposal of used sharp single use products and worn out products and tools in special designed containers for this purpose.

Handle the products with care to avoid mechanical damage and don't mix heavy devices with delicate ones during the cleaning.

Cleaning shall take place as soon as possible after the clinical procedure. In the meantime immerse the products in clinical solution to avoid drying of debris and soil.

3 Why all steps are important in the cleaning process

Sterilization is an essential step in the reprocessing of reusable dental instruments and accessories that have become contaminated, or are potentially contaminated, with saliva, blood or other biological fluids. This includes dental handpieces. The aim of sterilization is to break the chain of potential cross-infection between patients by killing micro-organisms including spores. However, prion proteins are not fully deactivated by the sterilization process. Therefore, effective cleaning is particularly important to physically remove contamination, including prion proteins, prior to sterilization.

Sterilization using a steam sterilizer is recommended as the most efficient, cost effective and safe method of sterilizing dental instruments and accessories in primary care dental practices. The sterilization process must be validated to ensure that instruments and accessories are reliably and consistently sterilized using predetermined and reproducible conditions. To kill microorganisms the instruments and accessories need to be exposed to steam at a specified temperature for a specific holding time.

Cleanliness of Instruments

Contamination of instruments and accessories with residual tissue, body fluids, oil or other deposits such as cements can prevent the direct contact between the steam and surfaces of the device that is necessary for effective sterilization. Also, any deposits left on instruments and accessories before sterilization might become fixed to the device making them more difficult to remove later. These deposits can also enter the water in the sterilizer reservoir and encourage growth of microorganisms or accumulation of endotoxins, which could contaminate devices processed subsequently. Ensure all items to be sterilized are clean and dry before placing them in the sterilizer chamber.

Loading of Instruments and accessories

Air removal might be impeded if instruments and accessories are not loaded correctly and steam may not contact every surface of every device. This steam contact is essential for sterilization to occur. Load the sterilizer according to the manufacturer's instructions and as specified at validation. Ensure instruments and accessories do not overlap. Open hinged instruments and accessories to expose all of the surface area to the steam. Place the devices on perforated trays, cassettes or racks that have been validated for use with the selected sterilization cycle. Do not overload the sterilizer chamber or individual trays or containers.

4 Workflow

This workflow with the processing steps shall be followed for preparation for reuse of Neoss reusable products. Further information of the different steps in the workflow is found in chapter 5 and 6.



1 Keep moisted until cleaning



2 Rinse



3 Disassemble if multiple parts



4 Immerse in pre-cleaning solution

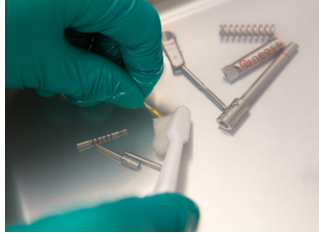

5 Clean with soft-bristle brush



6 Flush internal cavities

7 If cleaning in an automated dishwasher



7 Automated cleaning

7A, B & C If manual cleaning



7A Manual cleaning, ultrasond



7B Manual cleaning, rinse



7C Manual cleaning, dry with wipes



8 Inspect & assemble

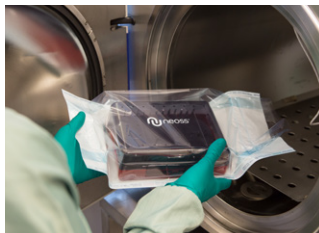

9 Pack & sterilize



10 Store

5 Cleaning and disinfection procedure of reusable products

Chapter 10 lists reusable products within the Neoss assortment.

This section describes in more detail the cleaning and disinfection procedure of the reusable products apart from the Ratchet which is described in chapter 6.

Repeated processing has a limited effect on reusable products, the service life is normally determined by wear and damage due to use.

Equipment needed

- Ultrasonic bath minimum required size for completely immersing the products (frequency 25 – 50 kHz).
- The temperature and amount of water and the enzymatic cleaner or detergent shall be as described in the IFU for the ultrasonic machine.
- Soft nylon brushes, syringes (20 ml), irrigation needles, absorbent papers etc.
- Purified or sterile water for rinsing.
- Appropriate protective dressing.

During and directly after the clinical procedure

Instruments are kept moist or immersed in sterile water during the clinical procedure to avoid drying.

After the clinical procedure rinse the products in tap water immediately to remove visible blood, tissue and debris.

Clean the components within two hours after the procedure.

Preparation for the cleaning after the clinical procedure

Always wear appropriate dressing and hand gloves as described in chapter 2 while handling of components being used in the clinical procedure.

Disassembling of multiple part products

Products consisting of multiple parts must be disassembled according to instruction before cleaning.

Enclosed in chapter 9 you'll find a list of Multiple part reusable products in the Neoss assortment and how these are disassembled.

Automated cleaning, disinfection and drying including pre-cleaning

Pre-cleaning:

Pre-clean the reusable products being used immediately after the clinical procedure.

- Immerse the instruments completely in a commercially available mild pre-cleaning solution for at least 5 minutes. Concentration and temperature according to label instruction.
- Clean mechanically with a soft-bristle brush (toothbrush type) working beneath the liquid level until visibly clean.
- Instruments with internal cavities should be flushed with at least 20 ml cleaning solution using a syringe.
- Rinse in running cold tap water.

Automated cleaning:

Use a washer-disinfector intended for surgical instrumentation that meets the requirements of ISO 15883.

Follow the instructions provided by the manufacturer of the washer-disinfector.

Place all instruments and clinical organizer in a stainless steel mesh basket provided by the washer-disinfector manufacturer. Ensure they are placed in an appropriate manner to avoid damage. Small disassembled parts should be placed in a stainless steel fine mesh basket with lid. Do not overload the basket.

The following parameters and equipment were used in the validation (washer-disinfector and cleaning program validated according to ISO 15883):

- Pre-rinsing 2 minutes with cold tap water (repeat 2 times)
- Cleaning 10 minutes at 55°C/131°F tap water with Getinge Clean Enzymatic Detergent (dosage range 2 – 10 ml/l according to label instruction)
- Post-rinsing 2 minutes with warm tap water (repeat 2 times)
- Final rinsing/disinfecting 1 minute in deionized water at 90°C/194°F with Getinge Clean Rinse Aid (dosage range 0.2 – 1.0 ml/l according to label instruction)
- Drying 15 minutes at 110°C/230°F

Manual cleaning, disinfection, rinsing and drying

Cleaning, Disinfection & Rinsing:

- Immerse the instruments completely in a commercially available mild pre-cleaning solution for at least 5 minutes. Concentration and temperature according to label instruction.
- Clean mechanically with a soft-bristle brush (toothbrush type) working beneath the liquid level until visibly clean.
- Internal cavities should be flushed with at least 20 ml cleaning solution using a syringe.
- Place all instruments in an ultrasonic washing unit 35 – 40 kHz using a stainless steel mesh basket in an appropriate manner to avoid damage. Small disassembled parts should be placed in a glass beaker. Do not overload the basket or beaker. Use an alkaline detergent or a neutral pH detergent suitable for ultrasonic cleaning with concentration and temperature according to label instruction. Clean the instruments for minimum 5 minutes.
- Remove from ultrasonic washer and rinse with sterile or at least deionized water.

Drying:

The instruments can be air-dried in controlled conditions or dried with lint-free wipes. Instruments with internal cavities can be dried with filtered compressed clean air (Class 1 or better, according ISO 8573-1:2010) to speed up the drying process.

Inspection

Visually inspect the instruments for damage or wear, like corrosion or discoloration of the instruments, and complete removal of visible soiling.

Damaged or blunt instruments should be discarded. See chapter 11 for guidance.

Assembling

Assemble products of multiple parts according to described in chapter 9.

Note: During entire handling make sure the components are placed in an appropriate manner to avoid damage. Components are checked for damage after each procedure and damaged components are removed.

6 Cleaning and disinfection of the Ratchet

After use and in preparation for pre-cleaning disassemble the Ratchet as described in chapter 9.

Automated cleaning including pre-cleaning

Pre-cleaning:

- Immerse the disassembled parts completely in a commercially available mild pre-cleaning solution for at least 5 minutes. Concentration and temperature according to label instruction.
- Clean mechanically with a soft-bristle brush (toothbrush type) working beneath the liquid level until visibly clean.
- Internal cavities should be flushed with at least 20 ml cleaning solution using a syringe.
- Place the Ratchet parts in an ultrasonic washing unit at 35 – 40 kHz.
Use an alkaline detergent or a neutral pH detergent suitable for ultrasonic cleaning with concentration and temperature according to label instruction.
Clean the parts for minimum 5 minutes.
- Rinse in running cold tap water.

Automated cleaning:

Use a washer-disinfector intended for surgical instrumentation that meets the requirements of ISO 15883. Follow the instructions provided by the manufacturer of the washer-disinfector.

Place the disassembled Ratchet in a stainless steel mesh basket provided by the washer-disinfector manufacturer making sure in an appropriate manner to avoid damage. Small disassembled parts should be placed in a stainless steel fine mesh basket with lid. Do not overload the basket.

Manual cleaning, disinfection, rinsing and drying

Manual cleaning, disinfection and rinsing:

- Immerse the disassembled parts completely in a commercially available mild pre-cleaning solution for at least 5 minutes. Concentration and temperature according to label instruction.
- Clean mechanically with a soft-bristle brush (toothbrush type) working beneath the liquid level until visibly clean.
- Internal cavities should be flushed with at least 20 ml cleaning solution using a syringe.
- Place the disassembled Ratchet in an ultrasonic washing unit 35 – 40 kHz using a stainless steel mesh basket making sure the components are placed in an appropriate manner to avoid damage.
Small disassembled parts should be placed in a glass beaker. Do not overload the basket or beaker.
Use an alkaline detergent or a neutral pH detergent suitable for ultrasonic cleaning with concentration and temperature according to label instruction.
Clean the Ratchet parts for minimum 10 minutes.
- Remove from ultrasonic washer and rinse with sterile or at least deionized water.

Drying:

After cleaning and rinsing dry the components immediately.

The Ratchet parts can be air-dried in controlled conditions or dried with lint-free wipes. Instruments with internal cavities can be dried with filtered compressed clean air (Class 1 or better, according to ISO 8573-1:2010) to speed up the drying process.

Inspection and assembling

Visually inspect the parts for damage or wear, like corrosion or discoloration, and complete removal of visible soiling. Damaged or blunt instruments should be discarded. See chapter 11 for guidance.

After every cleaning and prior to sterilization the marked areas in the Ratchet picture in chapter 9 should be slightly moistened with a small amount of implement care oil. This oil must be approved for steam sterilization and have a tested biocompatibility (like paraffinic white oil without corrosion inhibitors or any other additions). Recommended is to use the same kind of oil as used for the maintenance of the handpiece of the Drilling Unit.

Assemble the Ratchet as described in chapter 9.

7 Packaging & Sterilization

Packaging for sterilization

Single devices:

Place the instrument in a sterilization pouch suitable for use with your autoclave system for further processing and make sure it's correctly sealed.

System trays:

Mount the instruments in the silicone clinical organizer, place in the system tray according to the instructions for use. Place the system tray in a sterilization pouch suitable and seal it for use with your autoclave system for further processing.

The wrapping shall be suitable for steam sterilization and fulfilling the requirements in standard ISO 11607.

For USA the wrapping material shall be FDA cleared.

Sterilization

Outside US

Parameters for single devices and devices mounted in a system tray and sealed in pouches.

- Method: Moist heat sterilization
- Cycle: Pre – vacuum
- Temperature: 134°C/273°F
- Exposure time: minimum 3 minutes
- Pre-vacuum: 3 times <60 mbar
- Drying time: 20 minutes
- The autoclaves/sterilizers should conform to ISO 17665-1 or ANSI/AAMI ST79.
- Do not exceed 150°C/302°F, ensure that the autoclave's maximum load is not exceeded.

US specific

Parameters for single devices and devices mounted in a system tray and sealed in pouches.

- Method: Moist heat sterilization
- Cycle: Pre – vacuum
- Temperature: 132°C/270°F
- Exposure time: minimum 4 minutes
- Pre-vacuum: 3 times <60 mbar
- Drying time: 20 minutes
- The autoclaves/sterilizers should conform to ISO 17665-1 or ANSI/AAMI ST79.
- Do not exceed 150°C/302°F, ensure that the autoclave's maximum load is not exceeded.

Note: Parts that cannot be autoclaved such as instruments with plastic handles, plastic retention means for overenture and ScanPegs shall be disinfected.

According to EN ISO 17664 it's the user's and processor's responsibility to ensure that the recommended process parameters above are validated and controlled.

Neoss products can withstand temperatures up to 150°C unless otherwise stated.

8 Storage

- Check all products visually. Dispose damaged or blunt products in appropriate containers specified for this.
- Sterilized and packed instruments and kits must be stored in dry environment, at room temperature and out of direct sunlight.
- Never store instruments while they are still moist or wet.
- Validation of shelf life of packed and sterilized products is the responsibility of the dental clinic.

9 Assembling & disassembling of Reusable products with multiple parts

List of Neoss Reusable Products with multiple parts and how to disassemble them before cleaning:

Ratchet	Disassembled as described below.
Neoss System Tray	Lid, base and organizers shall be separated, instruments shall be removed from organizers.
Prosthetic Tray	Lid and base shall be separated.
Prosthetic instrument kit	Lid and base shall be separated, instruments shall be removed from base.
Tack Positioning Instrument	Disassemble by removing the protection cap. Assemble the protection cap again before sterilization.
Tack and Screw Cassette	Multi part product not possible to disassemble. Shall be cleaned and sterilized with open lid.

Neoss Ratchet – disassembling, assembling and maintenance

- After use and in preparation for pre-cleaning disassemble the Ratchet – this does not require any tools. The removal of the instrument becomes easier if the pin (5) is drawn away from the instrument.

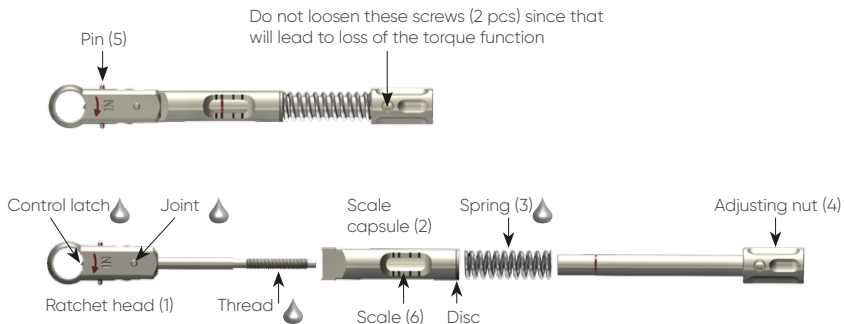

- After cleaning and rinsing dry all components immediately.
- Prior sterilization the marked areas in the Ratchet picture should be slightly moistened with a small amount of implement care oil (paraffinic white oil, without corrosion inhibitors or any other additions) which is approved for steam sterilization and have a tested biocompatibility. Recommended is to use the same kind of oil used for the maintenance of the Drilling units handpiece.
- Reassemble the Ratchet in a relaxed position using the adjusting nut (4) (setting about 10 Ncm). The labelling IN on the ratchet head (1) and scale (6) face the same direction.

Note: the Ratchet should always be stored in a relaxed position.

The lifetime of the Ratchet is primarily dependent on care and not the number of sterilization cycles. If after extensive usage if there are signs of wear or inappropriate care the Ratchet may also require calibration of the transmitted torque. Contact your local Neoss representative for more information about this service.

The Ratchet shall be disposed of if the parts are not moving smoothly, are difficult to dismantle or show signs of discoloration.

10 Reusable products

Repeated cleaning and sterilization processing has a limited effect on these products, the service life is normally determined by wear and damage due to use.

Examples of Neoss Reusable Products:

Twist Drill – Multiple Use



Drill Extender



Direction/Depth Gauge



Countersink



Screw Tap



Bone Profiler



Bone Remover Cover Screw



Implant Inserter



Wrench Adapter



Neo Screwdriver Machine/iGO Screwdriver Machine



Neo Screwdriver Manual/Manual Handle



Neoss System Surgical and Prosthetic Instrument Box

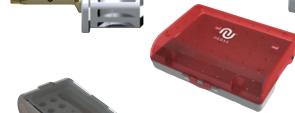

Prosthetic Tray



Ball driver



Angulation Gauge



Tack Positioning Instrument



Tack Mallet



Tack and Screw Cassette



11 Damaged products

The servicelife is normally determined by wear or overload during clinical use, or preparation after and prior to clinical use. Overload can cause deformation, fractures or disassemble parts. Wear can make products blunt. Storing wet products can cause corrosion. Overload or wear can also lead to loss of function such as overheating during drilling, loss of holding function of instruments during implant placement or tightening of screws.

For guidance in expected lifetime of a reusable product see chapter 12.

Below you'll find some examples of damaged products:

As delivered

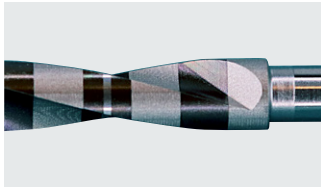

Damaged



Twist Drill – Multiple Use
Corrosion

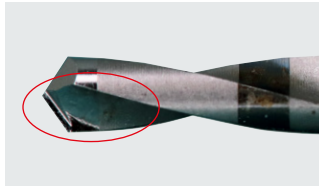
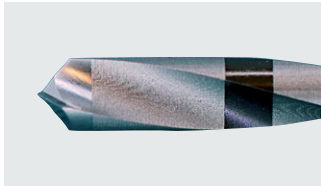

Twist Drill – Multiple Use
Blunt cutting edge



Drill Extender
Corrosion, fracture

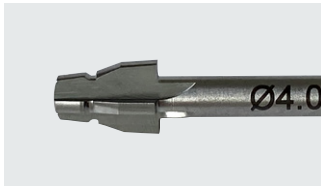

Countersink
Corrosion

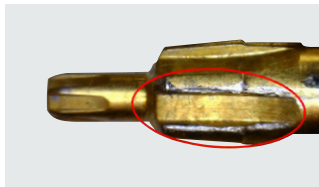
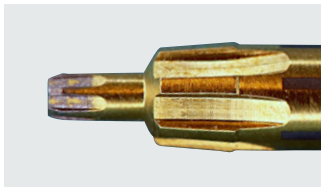

Implant inserter
Wear of TiN coating
Deformation due to over torque

As delivered

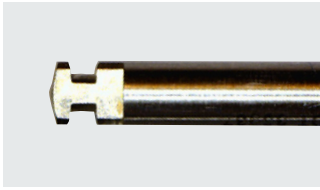

Damaged

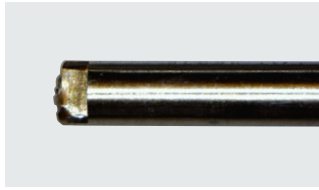

Instrument shaft
Fractured due to over torque



Screwdriver
Twisted tip due to overload



Manual Handle
Broken, decreased retention

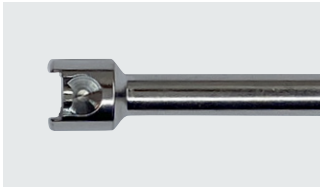

Ball Driver
Deformed due to misuse



Ratchet
Broken pin due to lack of lubrication



Ratchet pin
Corrosion and worn threads

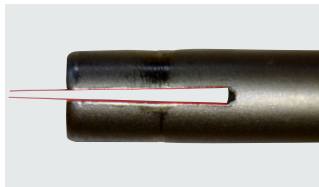

Tack positioning instrument
Corrosion, deformed

12 Lifetime

Bone cutting instruments:

A maximum of 10 re-use cycles are recommended for the multiple use devices. However, the instruments shall always be checked for damage before re-use. If damage is found then the instrument is to be disposed of.

Instruments, Scanpost, Trays:

The instruments and accessories are reusable devices that can be reused as long as the integrity and performance of the device are maintained. The devices must be inspected before each use for visible signs of damage, deformation, wear or corrosion. Devices showing any signs of visible damage or loss of functional compatibility (for example fit of instrument with mating components, lifting function etc) shall be discarded.

13 Questions & Answers

1. Which kind of oil shall I use for my Ratchet?

Answer: We recommend the same kind of oil as used for the drilling units handpiece.

2. How many times can I clean and sterilize the reusable instruments?

Answer: Repeated cleaning and sterilization processing has a limited effect on these products, the service life is normally determined by wear and damage due to use.

3. How do I know when an instrument is damaged and needs to be exchanged?

Answer: For example, corrosion can occur if the product is left in saline solution for a long time and also if stored wet – corrosion is visible for the eye.

Blunt edges of the drills can be visible and can also be felt when in use.

Instruments like screwdrivers and inserters can get a misfit if over torqued.

Instruments such as the Wrench Adapter and the Manual Handle can lose its grip function which is noticed by decreased retention.

See examples of damaged products in chapter 11.

4. What detergent shall I use?















Answer: If the detergent used in Neoss validation is not commercially available in your market you can use an equivalent one following the specific manufacturer's instruction. Neoss doesn't recommend any detergent in preference to another one for the equipment being used in your clinic.

5. Can I sterilize a non-sterile product in its blister?

Answer: No, you need to remove the blister in order to clean and sterilize the product.

14 Appendix

General packaging symbols

USE BY/EXPIRY DATE 	CATALOGUE NUMBER 	LOT/BATCH NUMBER 	DO NOT RE-USE (Single use only) 	TEMPERATURE LIMIT 
KEEP AWAY FROM SUNLIGHT 	MANUFACTURER 	DATE OF MANUFACTURE 	STERILIZED USING ETHYLENE OXIDE 	STERILE BY IRRADIATION (Contents of inner package sterile) 
NON-STERILE 	DO NOT USE IF PACKAGE IS DAMAGED 	MEDICAL DEVICE 	CONSULT INSTRUCTIONS FOR USE (Also available on www.neoss.com/IFU) 	CAUTION: Federal (USA) law restricts the sale of this device to or on the order of a licensed physician or dentist Rx only

Abbreviations

°C	Degree Celsius
°F	Degree Fahrenheit
mbar	milli bar
ANSI	American Nation Standards Institute
AAMI	Association for the Advancement of Medical Instrumentation
ST79	Steam Sterilization Standard
EN	European Norms
ISO	International Organization for Standardization
FDA	US Food and Drug Administration
kHz	kilo Hertz
pH	is a measure of how acidic/basic water is
ml	milli liter
IFU	Instructions For Use

Disclaimer of Liability

To keep the good performance of these products the instructions in this guideline are recommended to be followed. This document will supersede earlier productions of procedure manuals regarding cleaning, disinfection and sterilization. If an Instruction for Use for a specific product mentioned in this document describes another procedure than recommended here that specific IFU shall be followed.

Neoss products may only be used according to the manufacturers' instructions and recommendations. The user of Neoss products should determine their suitability for particular patients and indications. Neoss Limited disclaims any liability, expressed or implied, and shall have no responsibility for any direct, indirect, punitive or other damages arising out of or in connection with any errors in professional judgement or practice in the use or placement of the Neoss products.

Product images are not to scale and are subject to change.

Copyrights, design rights and trademarks: Neoss documents, software and designs may not be reprinted, copied or published in whole or part, without the written authorization of Neoss Limited. Neoss, 'N' logo, NeoLink, NeoLoc and Neoss ProActive are registered trademarks of Neoss Limited.

Caution: Federal (USA) law restricts this device to sale by or on the order of a licensed dentist or physician.

References

Source of text in chapter 3: Scottish Dental Clinical Effectiveness Programme SDcep, *Sterilization of Dental Instruments, Dental Clinical Guidance*, Dec 2011.

Customer service

Australia

Neoss Australia Pty. Ltd
PO Box 404
New Farm
QLD 4005
T +61 7 3216 0165
E info.au@neoss.com

Austria

Neoss GmbH
T +49 221 55405-322
F +49 221 55405-522
E info@neoss.de

China

Shanghai Legend Life Technology
Co., Ltd
4th floor, Block 6
1525 Mingqiang Road
Songjiang District
Shanghai 201612
P. R. China
T +86-21-6765 7130-617
F +86-21-6765 7131
E info@legendlifetech.com

Croatia

Medical Intertrade d.o.o
10431 Sveta Nedelja
HRVATSKA
T +385 1 33 74 020
F +385 1 33 36 035
E dental@medical-intertrade.hr

Denmark

Neoss AB
T +46 (0)31 88 12 80
E info@neoss.se

Germany

Neoss GmbH
Im Mediapark Sb
50670 Köln
T +49 221 96980-10
F +49 221 96980-199
E info@neoss.de

Italy

Neoss Italia S.r.l.
Viale Certosa 138
IT-20156 Milano
T +39 02 92952 1
E italia@neoss.info

Japan

Neoss Japan Co.
Y101 Building 5F
No. 1-4 Kanda-Sudacho
Chiyodaku
Tokyo 101-0041
T +81 3 5289 3511
F +81 3 5289 3512
E info@neoss.co.jp

Middle East & Africa

Neoss Limited
Unit 3737 Level 1
Jewelry & Gemplex 3
P.O. Box 5003315
Dubai
United Arab Emirates
E info.mea@neoss.com

Netherlands

Rotor, Medical Supplies B.V.
Rijksweg Zuid 51
NL-6071HV Swalmen
Netherlands
T +31-46-481 12 02
F +31-46-481 12 04
E mail@rotor-medical.com

New Zealand

Neoss Australia Pty. Ltd
T +61 7 3216 0165
E info.au@neoss.com

Norway

Neoss AB
T +46 (0)31 88 12 80
E info@neoss.se

Republic of Ireland

Neoss Ltd
T +44 1423 817-733
F +44 1423 817-744
E info@neoss.com

Spain

Formación, Gestión Y
Rendimiento, S.L
C. Nil Fabra 34-36.
Etslo 2 B
08012. Barcelona
Spain
T +34 931 408 770
E info@fgrdental.com

Sweden

Neoss AB
Arvid Wallgrens backe 20
SE-413 46 Göteborg
T +46 (0)31 88 12 80
E info@neoss.se

Arc Solutions AB
Box 13011
SE-250 13 Helsingborg
T +46 (0)42 301 74 40
E info@arcsolutions.se

Switzerland

Flexident AG
Amlehstr. 22
CH-6010 Kriens
T +41 413104020
E info@flexident.ch

Thailand

S.D.Tantavade Co., Ltd.
47 Samakkee 20, Samakkee Road
Thasai Muang
Nonthaburi 11000
T +66 2 952 4815 18
F +66 2 952 4819
E info@sdt1988.com

Turkey

Dentmark Sağlık Ürünleri Anonim Şirketi
Cevizli Mah. Cevizli D-100
Güney Yanyol Cad. No:2
Kuriş Kule Kat:3 D:52
Kartal-Istanbul PO: 34865
T +90 216 417 4040
E info@dentmark.com.tr

United Kingdom

Neoss Ltd
Windsor House
Cornwall Road
Harrogate
HG1 2PW
T +44 1423 817-733
F +44 1423 817-744
E info@neoss.com

United States

Neoss Inc.
21860 Burbank Blvd.,
Ste. 190 (North Entrance)
Woodland Hills, CA 91367
T +1 866 626-3677
F +1 818 432-2640
E contact.usa@neoss.com



Neoss AB

Arvid Wallgrens backe 20
413 46 Göteborg
Sweden
T +46 (0)31 88 12 80
W www.neoss.com



MD 75473



2797

The Neoss implant assortment has FDA clearance for immediate placement and function recognizing sufficient bone stability and appropriate occlusal loading to restore chewing function.