

Surgical Handbook



1. Surgical Handbook

Section	Page
1.1 General Features	1:3
1.2 Instrumentation and Component Assortment	1:4
1.3 Clinical Assessment	1:12
1.4 Clinical Treatment	1:14
1.5 Post Operative Care	1:23

1.1 General Features

The Neoss® Implant System provides a simple, easy to use means of anchorage for a single crown, bridge or denture thereby satisfying a wide range of aesthetic and functional requirements.

Simple implant installation and flexibility in prosthetic solutions provides optimal aesthetic restorations for a wide range of clinical variables.

This handbook serve as a clinical reference for surgical implant placement procedures.

The Neoss Implant System

The Neoss Implants are based on extensive research and development, the outcome of which is a state-of-the-art system, rationalized by design.

The implants have patented design and geometry which imparts specific features and benefits to the system.

Neoss implants may be used as a one or two-stage implant and are manufactured from Commercially Pure Titanium Grade IV with a subtractive surface. The system fulfils all clinical indications with a compact and rational range of implant components and instruments.

The Neoss System Surface

Neoss ProActive® Surface

The ProActive Implants have a superhydrophilic surface demonstrated by an immeasurably low contact angle. The completely unique method applied by Neoss to increase hydrophilicity is based on depositing hydrated ions onto the implant surface. Prior to making the surface superhydrophilic the implant is subjected to a multistage blasting, etching and cleaning treatment. The result of this is an implant which exhibits a coarse level of roughness (Sa 1.0µm) over the threaded part of the implant and a reduced roughness (Sa <0.4µm) over the flange of the implant. The ultraclean surface is achieved by a combination of surface processing, cleaning and packaging methods. In combination, these features demonstrate an accelerated and increased strength of osseointegration (compared to a grit-blasted and acid etched implant as demonstrated in animal models).

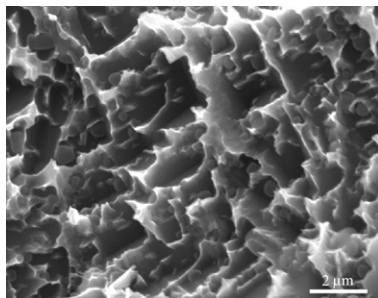

Neoss Implant Design

The Neoss Implant System incorporates TCF® geometry combining both Thread Cutting and Thread Forming (TCF®) features. This feature ensures stability in all bone qualities by a combination of thread cutting and compression thereby optimizing stability in poor bone quality and minimizing over compression in dense bone.

The implants are 'double threaded' for fast insertion and are designed to achieve additional stability in poor quality bone.

In order to optimize stability and allow seating whilst minimizing over compression, a secondary cutting face (TCF® design) engages and cuts dense bone areas compensating for the contoured design. The secondary cutting face extends along the major threaded part of the body depending on the implant type.

These features ensure that optimal stability is achieved. There is a unique relationship between the preparation site, instruments and the geometric features of the Neoss implants and the TCF® design. Please refer to the Drilling Sequence Protocols 1:3 and Drill Depth Guides 1:3 for specific details.

Neoss implant to abutment connection

The ONE prosthetic platform, across three implant ranges is unique to the Neoss Implant System. The same prosthetic components fit every standard implant. All standard Neoss implants, Ø3.5 and larger, have the same standard platform (SP) with the implant to abutment connection design called NeoLoc®. For Ø3.25 mm implants the implant connection has a smaller narrow platform (NP).

Neoss Esthetiline Solution

The Esthetiline solution enables simple, rapid and effective anatomical tissue contouring to be developed and optimized with matching standard and individualized restorative components in different materials.

1.2 Instrumentation and Component Assortment

The rationalized design of the Neoss Implant System enables implant placement and restoration to be carried out using the minimum number of components and instruments. Instruments used for implant placement are:

Neoss System Implant Kit

The implant is supplied in a kit. This kit is in the form of a 'sterile blister pack' and contains the Implant, Cover Screw, Healing Abutments × 2 and Healing Abutment Screw. The ProActive Edge implant is also provided with only the cover screw for cases using the Esthetic Healing abutment with ScanPeg.

All articles within the 'blister pack' are STERILE.

The Neoss Implants are packaged in a glass vial. The implant vial is placed into the Drill/Instrument Organizer for a 'no touch' delivery method with the use of the Implant Inserter or Implant Inserter Wrench. The Neoss Implant System is available in 7 implant diameters Ø3.5, Ø4.0, Ø4.5, Ø5.0, Ø5.5, Ø6.0 and Ø6.5, all with the prosthetic Standard Platform (SP), and in addition there is a narrow Neoss Ø3.25 mm implant with the prosthetic Narrow Platform (NP). The implants are available in six lengths 7, 9, 11, 13, 15 & 17 mm with some deviations, please refer to product catalog for detailed information about available implant types, diameters and lengths.



Implant vial packaging

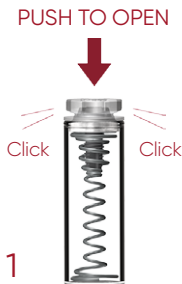

Cover screw (included in each implant kit)

The Cover Screw has a low profile and its diameter is the same as the implant-to-abutment connection. The Cover Screw (provided in the implant kit) is placed in the Drill/Instrument Organizer for easy pick-up and torqued to a maximum of 10 Ncm.



Note: Cover screw NP for Ø3.25 implants is color coded in royal blue.

Healing Abutments in PEEK

Two healing abutments are provided in each implant kit or sold separately. The healing abutments included in Ø3.5 – 4.5 implant kits are 2.7 mm and 5.0 mm high and 5.0 mm wide. The Ø5.0 – 6.5 implant kits include one healing abutment that is 5.0 mm high and 5.0 mm wide and one that is 3.3 mm high and 6.5 mm wide. The screw is torqued to a maximum of 10 Ncm.



Note: The healing abutments have a snap fit screw design. A gentle push is required to insert and remove the screw – this ensures positive connection during placement and removal from the mouth.

Note: Ø3.25 implant kit comes with a healing abutment that is 4.0 mm wide and 5.0 mm high with snap fit screw design. The healing abutment screw NP for Ø3.25 implants is color coded in royal blue.

Tip: It is recommended to use either tungsten carbide or diamond burs if adjusting the healing abutment.

Esthetic Healing Abutments with ScanPeg

Esthetic Healing Abutments are available in various anatomical shapes ranging from incisors to molars with the purpose to create a soft tissue profile during healing. For more information about the use of Esthetic Healing Abutments refer to section 4.2.

Esthetic Healing Abutments are equipped with features making it possible to be used with a ScanPeg, i.e. a scan body, to record a digital impression with an intraoral scanner without removing the healing abutment from the implant. ScanPeg can be used for digital impression taking of single and multiple unit implant cases.

Esthetic Healing Abutments are made from PEEK and engage the internal connection of the implant to determine a fixed orientation.

The abutment is seated on the implant. The titanium screw is tightened to a torque of 10 Ncm. The abutment is left in place for the desired healing period. Esthetic Healing Abutments with screws are co-packed with a ScanPeg and supplied sterile. ScanPeg provided separately as spare parts are non-sterile and needs to be disinfected – it cannot be autoclaved.

Esthetic Healing Abutments are part of the Esthetiline solution.



Titanium Healing Abutments

Available in heights 2, 4, 6, 8 & 10 mm, they have a diameter of 4.0 mm and are sold separately in a sterile pack. They are used in conjunction with the Neo screwdriver and are tightened to a maximum of 10 Ncm.



Drills, Countersinks and Screw Taps

Neoss drills are for single use and delivered in a sterile condition for immediate use.

Neoss Countersinks and Screw Taps are for multiple use and delivered in sterile condition for immediate use. Please refer to the "Guideline for cleaning & maintenance Neoss reusable products" (14077) for cleaning and re-sterilization.

Please refer to the Drilling Protocols in section 1.4 for recommended drills for the placement of different Neoss implant diameters and types.

Note: Specific laser markings on shafts for identification: E for Edge, T for Tapered, S for Straight.



Drill Extender

The Neoss System Drill Extender has an extension length of 14 mm and subsequently will extend 33 mm drills to 47 mm.

Note: Drill Extender only to be used with drills and not implant inserters.



Direction Depth Gauge (4 pcs)

The Neoss System Direction Depth Gauge is a multi purpose instrument. It has 2 mm and 3 mm tips which can be used to measure the depth of the osteotomy during preparation – depth markings are also visible on an x-ray. It can also be used directly in an osteotomy as an alignment pin when placing multiple implants. In addition the threaded portion enables it to be screwed into the implant to assist in multiple placement alignment. It is also equipped with a hole for a floss ligature.

Note: The 3 mm tip cannot be used for depth purposes in conjunction with the Twist Drill, Tapered Ø3.0.



Depth Gauge Probe

The Depth Gauge Probe is used to determine depth of a drilled osteotomy.

There are two sides with different functions.

One is fitting in the preparation osteotomy made by the Ø2.2 mm drill (initial hole in the drill protocol) and has apart from the depth markings a ball end for inspection of the bone surface with tactile feedback.

The other side fits the hole made by the Ø3.0mm drill and larger to verify drill depth.

These two features are connected with a handle for manual use improving ergonomic handling for the user.

The Depth Gauge Probe is a measuring and inspecting instrument with markings corresponding to drill markings and thereby implant lengths.



Implant Inserter

The Neoss Implant System Inserter engages the internal connection of the implant in a 'no touch' delivery method direct from the glass vial. The tip of the inserter also engages the cover screw and the membrane screw to facilitate placement.

Note: Should the cover screw be inadvertently over tightened with the implant inserter and it 'spins' within the connection then 'stripping' or 'rounding out' the connection has not occurred. The unique design of the implant inserter does not engage the entire width of the connection allowing for removal with the Neo screwdriver should over tightening occur.

Note: For optimal alignment of selected abutments and minimal preparation, use the inserter cams indicated by the laser markings to index the implant, i.e. position a cam and an implant groove in the buccal lingual direction.

Note: The laser markings are located 3 and 5 mm above the point of contact with the implant to assist during flapless surgery.

It is available in three lengths 17, 22 and 32 mm and for Ø3.25 mm implants in 24 and 32 mm.

Note: The Inserters NP for Ø3.25 mm implant are laser marked NP and color coded in royal blue for easier identification.

Note: Indication of the inserter cams is available on all inserters except the 17 mm inserter due to space limitation.

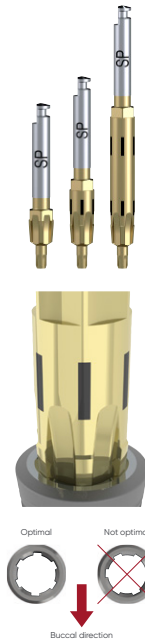

Insertion Handle – Large

The Insertion Handle – Large facilitates manual insertion of implants and membranes.

It is a single part product with an ergonomic handle for a comfortable one-hand grip.

The inner geometry of the Insertion Handle – Large has an internal hexagon that is compatible with the hexagon on the Neoss implant inserters to transfer high torque for manual insertion of the implants.

The tip of the Implant Insertion SP is equivalent with the Neo Screwdriver. This makes the Insertion Handle – Large mounted with an Implant Inserter SP suitable for placement of the Neoss membrane screws.

Note: Follow osteotomy and not apply axial force during insertion.



Wrench Adapter

The Wrench Adapter is an adapter for implant inserters to fit into the ratchet for manual insertion of the implant. The Wrench Adapter has an internal hex compatible with the external hex on the implant inserters to transfer torque.

Note: The Wrench Adapter is only compatible with implant inserters with the hex.

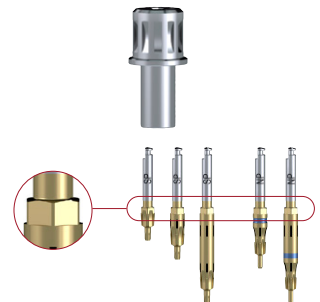

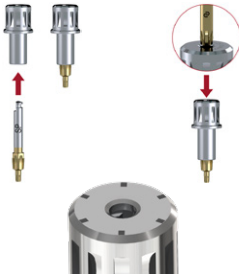

Note: The Wrench Adapter and the implant inserter are properly assembled when the external hex on the implant inserter is fully seated inside the internal hex of the Wrench Adapter.

Note: If needed, use a screwdriver tip or similar to disassemble the implant inserter from the Wrench Adapter by pushing through the hole in the Wrench Adapter.

Note: Laser markings on the top surface indicate the cam positions of the implant inserter and makes it easier to index the implant if applicable.

Bone Remover Cover Screw and Bone Profiler

During healing bone can grow around the implant and over the cover screw to such extent that it can be difficult to remove the cover screw but also affect the seating of the healing abutment, temporary abutment or final abutment.

The seating issue also occur after the use of healing abutment prior to seating a temporary abutment or final abutment.

Select instrument depending on bone removal situation:

- Before cover screw removal: Bone Remover Cover Screw
- Remove excess of bone around the top of the implant for proper seating of parts such as healing abutments or other abutments to the implant: Bone Profiler

Bone Remover Cover Screw and Bone Profiler are sterile packaged in a blister/box.

See IFU for all details.

Bone Remover Cover Screw



1. Select Bone Remover Cover Screw type depending on implant platform (SP or NP).
2. Secure access to the screwdriver connection on the cover screw.
3. Manual or machine usage, preferably manual:
Manual: Use in conjunction with the Wrench Adapter or Manual Handle.
Machine: Use in conjunction with a handpiece at maximum 40 rpm.
4. Centre the steering tap inside the screwdriver connection.
5. Keep axial alignment to the cover screw until stop.
6. Manually remove remaining bone from cover screw if required.

Proceed with bone removal and bone profiling at implant level with Bone Profiler if required.

Note: Bone Remover Cover Screw SP is not compatible with the cover screw provided with Preparable Ti Abutment Wide Emergence.

Bone Profiler

1. Select Bone Profiler type depending on implant platform (SP or NP) and the size of the abutment to be used. If SP and seating of Narrow Incisor abutments use SP Ø5.1 and if SP and seating of wider abutments use SP Ø6.6.
2. Manual or machine usage, preferably manual:
Manual: Use in conjunction with the Wrench Adapter or Manual Handle.
Machine: Use in conjunction with a handpiece at maximum 40 rpm.
3. Keep axial alignment to the implant until stop.

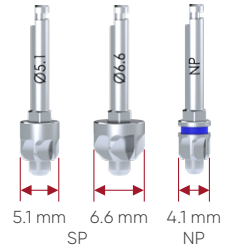

Bone Profiler compatibility emergence profiles:

Bone Profiler Ø5.1 mm SP with the Healing Abutment PEEK 5mm:

The Bone Profiler is designed to have slightly larger profile to enable fitting of Neoss standard healing abutments and final abutments with an outer diameter of 5 mm.



Bone Profiler Ø5.1 mm SP with the Esthetic Healing Abutment – Narrow incisor:

The Bone Profiler Ø5.1 mm SP will remove bone up to 2 mm from the implant/abutment interface. This would be sufficient if the implant is not placed deep in the bone. For all other esthetic abutment shapes (wide incisor, canine, pre-molar and molar) the larger Bone Profiler Ø6.6 mm SP should be used.



Bone Profiler Ø6.6 mm SP with the Healing Abutment PEEK 6.5×3.3 mm:

The Bone Profiler is designed to have slightly larger profile to enable fitting of the Ø6.5 mm healing abutment.



Bone Profiler Ø6.6 mm SP with the Esthetic Tissue Former – Molar:

Due to the large size of the esthetic molar shape the Bone Profiler will only remove bone up to 1.4 mm from the implant/abutment interface. Esthetic abutment shapes (wide incisor, canine, pre-molar) are all within the cutting profile of the Bone Profiler Ø6.6 mm SP.



Compatibility emergence profiles, cont.

Recommendation chart Bone Profiler emergence

Abutment types O = Optimized N = Not compatible or under-preparation OP = Over-preparation of bone (full profile compatibility not possible)	Healing abutment Ø4	Healing abutment Ø5	Healing abutment Ø6.5	Esthetic – Narrow incisor	Esthetic – Wide incisor	Esthetic – Canine	Esthetic – Pre-molar	Esthetic – Molar	Healing abutment Wide emergence (31317)
Bone Profiler Ø5.1 mm SP	N	O	N	O	N	N	N	N	N
Bone Profiler Ø6.6 mm SP	N	OP	O	OP	O	O	O	O	O
Bone Profiler Ø4.1 mm NP	Y	N	N	N	N	N	N	N	N



Neo Screwdriver

The Neo machine screwdrivers are used in a handpiece for machine use or in conjunction with the Manual Handle for manual use to work with the Neo screwdriver connection. It is recommended to use Manual Neo Screwdrivers in conjunction with the ratchet. Neo Machine screwdrivers are available in 22 and 32 mm lengths and have a carry function.

Note: The Neo screwdriver connection is used for through out the Neoss Implant System apart from Angulated Screw Channels (ASC) – Access Abutment components, Cover Screws, Provisional Screws, Impression Coping Screws, Neo Laboratory and Neo Abutment Screws regardless of implant platform or working on abutment level.



iGO Screwdriver

The iGO machine screwdrivers are used for restorations with iGO screw seatings including Angulated Screw Channels (ASC) with up to 25 degrees angulations. The iGO screwdrivers are available in 22 and 32 mm lengths and are used in a handpiece or with the Manual Handle with or without the Ratchet. The iGO screwdriver has a carry function.

Note: iGO components are not compatible with Neo Screwdrivers and abutment/prosthetic screws with Neo seating.



Manual Handle

The Manual Handle can be used to transform a machine screwdriver into a hand screwdriver. Do not use the manual handle with the Implant Inserters in conjunction with the ratchet as overtightening may damage the inserter.

Ratchet

The torque ratchet is designed for the controlled manual insertion of implants, and tightening abutment screws under a defined torque. The appropriate instrument (i.e. Manual Handle or Wrench Adapter) is inserted and carried by the ratchet head.

Please refer to the Guideline cleaning & maintenance Neoss reusable products (14077) for more information.



Impression Coping and Replica

The impression coping is designed for open tray or closed tray impression and is packaged with the implant replica. The impression coping is available in 8, 11 and 18 mm lengths. It is also available in an 8 mm length to the Multi-Unit and Access abutment and 11 mm to the Ø3.25 mm implant.

Note: If the impression screw engages the implant then the coping should be correctly seated. In case of uncertainty radiographic verification is recommended.

Note: The Impression coping NP for Ø3.25 mm implant is color coded in royal blue.

A specific open tray impression coping is available in 8 and 13 mm for situations when increased retention is required. It is packaged with the implant replica.

Please refer to the Neoss Implant System Laboratory or Restorative Handbook for detailed information on both open and closed impression techniques.



Esthetic Tissue Formers

Esthetic Tissue Formers serve as provisional abutments and are available in various anatomical shapes ranging from incisors to molars. These can be further customized to meet individual treatment needs and are recommended for single unit. Optionally, Esthetic Tissue Formers can be used as healing abutments.

The Esthetic Tissue Formers are made from titanium and a bondable polymer and engage the internal connection of the implant to determine a fixed orientation.

The Esthetic Tissue Formers are part of the Esthetiline solution.

Please refer to the Neoss Implant System Laboratory and Restorative Handbook for detailed information on use of the Esthetic Tissue Formers.



Provisional Titanium Abutments

The Provisional Titanium Abutments are designed with a 0.7 mm collar and are available both for single unit (Mono) and multiple unit (Multi) situations. The Mono is available both with and without retention rings (screw retained and cement retained). The Provisional Abutment Multi can be used both on implant and Access level with appropriate screws. The Provisional Titanium Abutments may also be used for wax-up and scanning. They also have a flat side for anti-rotation of the crown. All Provisional Titanium Abutments come with a plastic coping. Please refer to the Neoss Implant System Laboratory and Restorative Handbook for detailed information on use of the Provisional Titanium Abutments.

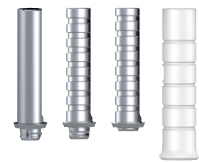

1.3 Clinical Assessment

Pre-operative Examination

Pre-operative examination includes a general evaluation of the patient's health, a clinical and a radiographic examination.

Attention is paid to the soft and hard tissues, dental history, restorative status and occlusion. Radiographic analysis provides an evaluation of the anatomy, evidence of pathology and bone quantity and an indication of bone quality. Initial radiographic evaluation and clinical assessment in conjunction with dedicated Neoss X-ray Planners can provide an indication of the suitability or not of a patient for treatment with implants.

Implant diameter (mm)	ProActive Edge implants flange diameter (mm)	ProActive Tapered implants flange diameter (mm)	ProActive Straight implants flange diameter (mm)
Ø3.25	–	–	Ø3.5
Ø3.5	Ø4.0	Ø4.0	Ø4.0
Ø4.0	Ø4.3	Ø4.3	Ø4.0
Ø4.5	Ø4.9	Ø4.9	Ø4.5
Ø5.0	Ø5.4	Ø5.4	Ø5.0
Ø5.5	–	Ø5.9	Ø5.5
Ø6.0	–	Ø6.0	
Ø6.5	–	Ø6.7	

If a patient is considered potentially suitable for implant placement at a preliminary examination then further investigations should be undertaken. These will vary depending on the complexity of each individual case. In general however, it is often valuable to produce articulated study casts. These can be used to assess interocclusal and intraocclusal relationships, occlusal guidance and the presence of interferences. Such models can also be used in the fabrication of diagnostic wax-ups, stents and temporary restorations.

Soft and hard tissue stents can also be fabricated from CT data in more complex cases.

Before treatment commences the patient is informed about the results of the pre-operative examination and is given a clear explanation of the proposed treatment, including expected outcomes and risks involved. Patients should indicate their acceptance of treatment by signing an appropriate consent form.

Indications for Implant Treatment

The Neoss ProActive® implants are endosseous dental implants intended for surgical placement in the maxillary or mandibular bone as a permanent anchorage for prosthetic products that replaces lost natural teeth and restore chewing function, speech and aesthetic appearance.

Cover Screws and Healing Abutments are intended to protect the implant-abutment connection from bone or soft tissue in-growth when connected to the Neoss implants or Access Abutments during healing and before prosthetic delivery. Healing abutments also support and shape the soft tissue healing as a non-loaded part during the healing period prior to delivery of the prosthetic restoration.

Implants, Cover screws and Healing abutments are intended for single use for a single patient.

Contraindications to Implant Treatment

General contraindications

- The patient's medical status precludes surgical treatment.
- Patients with mental psychosis and unrealistic treatment expectations.
- Alcohol and drug abuse.
- As well as the above listed criteria, consideration should also be given to contraindications for implant placement as published in numerous reference books readily accessible to healthcare professionals.

Implant-Bone Relationship

The implant site must be prepared in such a way that:

- the implant can be placed in a simple way
- the installed implant achieves a high level of primary stability
- there is no damage to vulnerable areas of local anatomy including the maxillary sinus, nasal floor and inferior dental canal
- there is no damage to the bone by overheating or trauma

Factors influencing the implant-bone relationship are:

- bone quantity
- bone quality
- diameter of the drilled implant site
- depth of the drilled implant site
- cutting and compression properties of the implant
- use of a countersink or screw tap

Bone Quality

Dense, compact bone provides good immediate support for the installed implant, whilst more open trabecular bone may not provide an optimal level of primary stability at placement. Very dense bone may however suffer from a restricted blood supply and compromise vitality.

Reduced bone quality combined with reduced bone quantity might be a contraindication for the placement of implants. Planning prosthetic and restorative treatment including the type and design of the prosthesis, must be related and planned with regard to these factors. Bone quality also varies from person to person, jaw to jaw and within the same jaw.

Bone Quantity

The amount of bone available for implant retention differs from person to person, jaw to jaw and also between different areas in the same jaw. Due to degenerative processes in the alveolar bone, edentulous areas resorb in both vertical and horizontal directions.

Anatomical structures such as the maxillary sinuses and the nasal floor give little room for resorption in the upper jaw before the implant support is compromised. In the lower jaw the posterior areas are frequently left without implant installation because of the close relation to the inferior alveolar nerve.

Horizontal resorption may leave too narrow alveolar crest and also lead to the implant being placed in an unfavourable direction.

1.4 Clinical Treatment

Pre-operative Handling

1. Proper planning before surgery and correct preparation of the implant site ensures efficient and accurate installation. It is also expected that clinicians working with the Neoss Implant System have a good understanding of the principles of implant surgery and the restorative phase. Access for the surgical instrumentation should be determined before starting the procedure.
2. Premedication is given based on individual indications. Typically, non-allergic patients may be given a 3g sachet of amoxicillin one hour before implant placement and 250mg four times daily post treatment for one week prophylactically.
3. Local anaesthesia is given in desired areas. Additional anaesthesia is given during surgery when needed.
4. Mouth-rinsing with 0.2% chlorhexidine solution for 1 minute.
5. The areas around the mouth are cleaned with 0.2% chlorhexidine solution and the patient is draped with sterile operating sheets covering the body and the head.

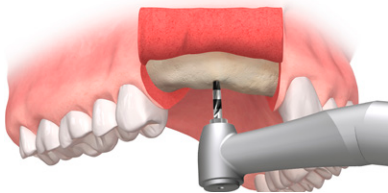
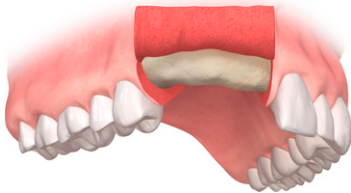
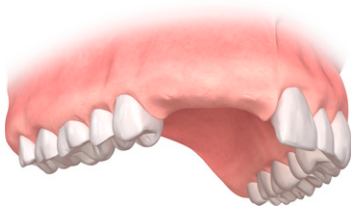

Preparation of the Implant Site

1. The surgical site is exposed by an incision on top of the alveolar ridge or placed remote from the crest as judged by the surgeon to be the most adequate way of performing the operation.
2. A buccal and a lingual mucoperiosteal flap are elevated. The incision and flap elevation are extended to enable easy access to/and control over the implant sites and to permit satisfactory registration of the jaw morphology.
3. The positions of the implant sites are determined and can be marked on the bone with a round bur, lance drill or the 2.2 mm twist drill. Incremental site preparation is carried out as recommended in the Neoss Implant System Drilling Protocols (on the following page). Recommended speed for drills is 800–2000 rpm using lower speed for larger drills, 800 rpm for countersinks and 20 rpm for screw taps.

Hint: If the alveolar ridge is knife-edged and too narrow it is suggested that the ridge is reduced with a bur or a bone file until at least 1 mm bone tissue is available to circumscribe the implant.

The ideal distance between each implant is 3.5–4.0 mm which gives a minimum center to center distance of 7.0 mm. Angulation can be checked with the Direction Depth Gauge after preparation with either the 2.2 mm or 3.0 mm Twist Drill.

Hint: Pre-operative clinical and radiographic evaluations, together with the established overview of the jaw morphology, now play important roles in the decision-making process.

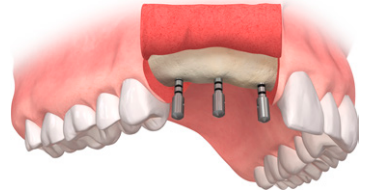

In partially edentulous situations the position of the implants and their relationship to the remaining dentition must be considered.

All preparation of the bone tissue is carried out under profuse irrigation with saline and using an intermittent drilling technique. This prevents overheating the bone and creates a pumping effect for efficient removal of bone debris.

The instruments can be placed in sterile solution (saline) during surgery if the instruments are used for more than one preparation.

Drill Depth Guides







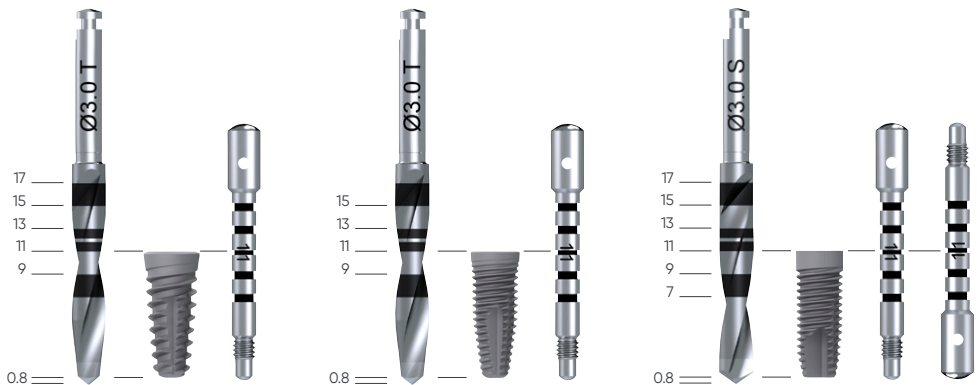



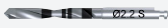





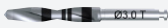







This guide shows an 11 mm implant in relation to a twist drill and depth guide. Please note actual distance to drill tip is 0.8 mm longer than the reference line.

Note: Depth markings on Lance Drill at 3, 5 and 7 mm, and at 7 and 9 mm on Pilot Drill.

Note: The 3 mm tip cannot be used for depth purposes in conjunction with the Twist Drill, Tapered $\varnothing 3.0$.



Drilling Protocol, ProActive Edge Implants

	ProActive Edge Ø3.5 mm	ProActive Edge Ø4.0 mm	ProActive Edge Ø4.5 mm	ProActive Edge Ø5.0 mm	Drill Stop
 Ø2.2 S					
 Ø3.0 T					
 Ø3.4 T					
 Ø3.9 T					
 Ø4.4 T					
 Countersink	Ø3.5 E	Ø4.0 E	Ø4.5 E	Ø5.0 E	

Bone quality



Guidelines

- Start at the top of the column with the Ø2.2 mm twist drill.
- Move down to the next marking for the chosen bone quality and prepare the site with the drill corresponding to that marking. Dashed markings are non-mandatory unless it is the last preparation step.
- Keep moving down the column until the final preparation is performed at the chosen bone quality marking.

Example: The drill sequence for a Ø4.0 implant in dense bone starts with the Ø2.2 mm twist drill followed by the final preparation step (Ø3.4 T). The dashed Ø3.0 T drill step can be omitted.

Use of a countersink is not required in situations where under-preparation of the cortical bone is desirable, as for soft bone, in order to increase cortical anchorage.

Note: The guiding portion of the Countersink Edge is designed to match the drill for regular bone. If a narrower osteotomy for soft bone needs countersinking it might be required to widen the cortical part of the osteotomy first with the regular bone drill to seat the countersink properly.

















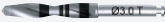

































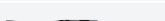





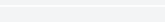





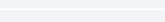





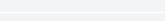





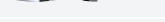





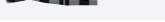

Additional notes

The Edge implant allows for further under-preparation in Soft bone.

In presence of dense bone, additional care is taken during insertion. The thread cutting and forming design of the implant acts as a screw tap. Use reverse torqueing 1/2–1 turn before continuing.

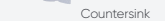
Neoss screw taps are not compatible with the ProActive Edge implant. The drills are the same bone cutting instruments as used for ProActive Tapered.

Drilling Protocol, ProActive Tapered Implants

	ProActive Tapered Ø3.5 mm	ProActive Tapered Ø4.0 mm	ProActive Tapered Ø4.5 mm	ProActive Tapered Ø5.0 mm	ProActive Tapered Ø5.5 mm	Drill Stop
 Ø2.2 S						
 Ø3.0 T						
 Ø3.2 S						
 Ø3.4 T						
 Ø3.6 S						
 Ø3.9 T						
 Ø4.1 S						
 Ø4.4 T						
 Ø4.6 S						
 Ø4.9 T						
 Ø5.1 S						
 Ø5.5 T						
 Ø4.0 T Countersink	Ø3.5 T Optional use	Ø4.0 T Optional use	Ø4.5 T Optional use	Ø5.0 T Optional use	Ø5.5 T Optional use	
 Ø4 Screw Tap	Ø3.5 Optional use	Ø4.0 Optional use	Ø4.5 Optional use	Ø5.0 Optional use	Ø5.5 Optional use	
	Bone quality	 Soft IV & III	 Regular II	 Dense I		

Guidelines

- Start at the top of the column with the Ø2.2 mm twist drill.
 - Move down to the next marking and prepare the site with the drill corresponding to that marking.
- Drill step for Soft bone not intended for **Regular** and **Dense** bone (indicated with dash style).*
- Drill step for Regular bone required before drill step for **Dense** bone.*
- Drill step for **Dense** bone does not require drilling to full depth.*

Additional notes











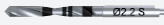













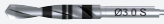



















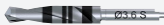

















The Tapered implant allows for further under-preparation in Soft bone.

Screw taps available but not required.

In presence of dense bone, additional care is taken during insertion. The thread cutting and forming design of the implant acts as a screw tap. Use reverse torqueing 1/2–1 turn before continuing.

Twist drill Ø2.2, Dense bone drills and screw taps in the ProActive Tapered implant drill protocol are the same bone cutting instruments as used for ProActive Straight implant drill protocol.

Drilling Protocol, ProActive Straight implants

	ProActive Straight Ø3.25 mm	ProActive Straight Ø3.5 mm	ProActive Straight Ø4.0 mm	ProActive Straight Ø4.5 mm	ProActive Straight Ø5.0 mm	ProActive Straight Ø5.5 mm	Drill Stop
 Ø2.2 S							
 Ø2.85 S							
 Ø3.0 S							
 Ø3.2 S							
 Ø3.4 S							
 Ø3.6 S							
 Ø3.9 S							
 Ø4.1 S							
 Ø4.4 S							
 Ø4.6 S							
 Ø4.9 S							
 Ø5.1 S							
 Countersink	Ø3.25 Optional use	Ø3.5 Optional use	Ø4.0 Optional use	Ø4.5 Optional use	Ø5.0 Optional use	Ø5.5 Optional use	
 Screw Tap	Ø3.25 Optional use	Ø3.5 Optional use	Ø4.0 Optional use	Ø4.5 Optional use	Ø5.0 Optional use	Ø5.5 Optional use	
		 Regular		 Dense			

Guidelines

- Start at the top of the column with the Ø2.2 mm twist drill.
- Move down to the next marking for the chosen bone quality and prepare the site with the drill corresponding to that marking.
- Keep moving down the column until the final preparation is performed at the chosen bone quality marking.

Drill step for Regular bone recommended before drill step for Dense bone.





Additional notes

*The Neoss drill assortment allows for individualized drill protocol in **Soft bone**.*

Screw taps available but not required.

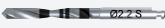
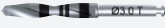
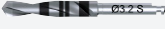
In presence of dense bone, additional care is taken during insertion. The thread cutting and forming design of the implant acts as a screw tap. Use reverse torqueing 1/2–1 turn before continuing.

Drilling Protocol, ProActive Wide Ø6.0 & Sinus Ø6.5 implants

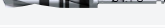
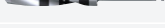
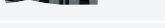
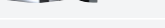
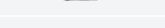
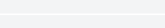
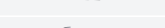
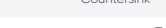
	ProActive Ø6.0 mm	ProActive Ø6.5 mm
 Ø2.2 S	○	○
 Ø3.0 T		
 Ø3.2 S		
 Ø3.4 T	○	○
 Ø3.6 S		
 Ø3.9 T		
 Ø4.1 S		
 Ø4.4 T		
 Ø4.6 S		
 Ø4.9 T	○	○
 Ø5.1 S		○
 Ø5.5 T	○	
 Ø6.0		○
 Ø6.0 T Countersink	○6.0 Optional use	○6.5 Optional use

Bone quality

○ Soft
IV & III

○ Regular
II

Guidelines

- Start at the top of the column with the Ø2.2 mm twist drill.
- Move down to the next marking and prepare the site with the drill corresponding to that marking.
- Keep moving down the column until the final preparation is performed at the chosen bone quality marking.

Drill step for Regular bone recommended before drill step for Dense bone.

Additional notes

*The Neoss drill assortment allows for individualized drill protocol in **Soft bone**.*

In presence of dense bone, additional care is taken during insertion. The thread cutting and forming design of the implant acts as a screw tap. Use reverse torquing 1/2–1 turn before continuing.

Neoss Implant Insertion – Machine

After careful preparation of the surgical site the implant is inserted as follows:

1. The lid is removed to expose the implant contained in the glass vial.
2. The implant is handled and installed by means of an Implant Inserter. It is available in three lengths 17, 22 and 32 mm and for Ø3.25 mm implants in 24 and 32 mm.



3. The Implant Inserter is placed into the implant and manually rotated to engage the internal connection design of the implant. To ensure proper carrying capacity the inserter is then lightly pushed into the implant before being lifted out of the vial. Do not rotate the implant when lifted out.

4. The machine installation of the implant is carried out at low speed – recommended maximum of 20 rpm. Torque control can be used – a maximum of 45 Ncm is recommended.

Note: Use the inserter cams and indications to index the implant if applicable.

Note: Do not use the Manual Handle with the Machine Implant Inserters in conjunction with the ratchet as excessive torque values may be reached damaging the Manual Handle.

Note: Take care during the insertion of Neoss ProActive® Edge as the large thread pitch allows for fast implant insertion and seating.

5. If desired use the ratchet in conjunction with the Wrench Adapter for the final levelling of the implant. Grip the shaft close to the center. Use only light finger force. Excessive torque must not be applied using the ratchet wrench.

Tip: The Implant Inserter or Wrench Adapter can simply be lifted out of the implant following placement. A gentle sideways 'rock' of the handpiece will release the inserter easily from the implant. It does not require unscrewing.

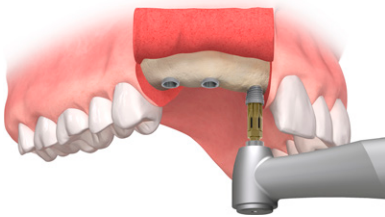

Neoss Implant Insertion – Manual

After careful preparation of the surgical site the implant may also be manually inserted as follows:

1. The lid is removed to expose the implant contained in the glass vial.



2. An Implant inserter is mounted in the Wrench Adapter or Insertion Handle – Large.

Note: Use only Implant inserter 22 mm or longer in conjunction with the Insertion Handle – Large for easier disassembly.



3. The Implant Inserter is placed into the implant and rotated to engage the internal connection design of the implant. To ensure proper carrying capacity the inserter is then lightly pushed into the implant before being lifted out of the vial. Do not rotate the implant when lifted out.



4. Insertion of the implant may be carried out manually with the use of the Wrench Adapter alone or in combination with the ratchet, or by using the Inserter Handle – Large.

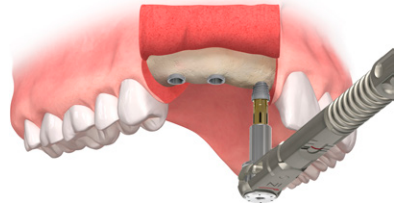

5. For the final levelling of the implant it is recommended to use the ratchet in combination with the Wrench Adapter. Grip the shaft close to the center. Use only light finger force. Excessive torque applied using the ratchet wrench must be avoided.

Note: Laser markings on the top surface indicate the cam positions of the inserter and makes it easier to index the implant if applicable.

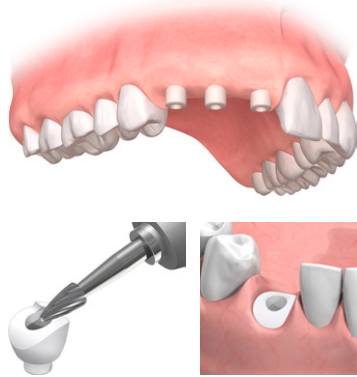

Single Stage Surgical Procedure

Hint: For a one stage procedure the implant is commonly inserted so that the flange is positioned above the alveolar crest.

1. After final positioning of the implant the appropriate Healing Abutment and corresponding Healing abutment screw (for example the one provided in the Implant Kit) is placed in the implant. The Healing abutment screw is tightened up to a maximum of 10 Ncm.

Note: The healing abutments are made of PEEK and may easily be adjusted by grinding with a bur. The height of the Esthetic Healing Abutments shall not be adjusted since the scanning accuracy can be impaired.

Note: The Esthetic healing abutment profile of the gingival margin is fixed in relation to the non-rotational feature on all Esthetiline abutments and thus related to the position of the implant – indexing. The Esthetiline solution is best applied by ensuring one groove in the implant to be oriented in the buccal direction during implant installation.

Note: In order to protect the screw channel of the Esthetic Healing Abutments and thereby the scanning accuracy, fill the cavity with a PTFE tape alternatively silicon impression paste at placement.

Alternatively a Titanium Healing Abutment of the desired length (2, 4, 6, 8, 10 mm) may be used.

Two Stage Surgical Procedure

Hint: For a two stage procedure the implant is commonly inserted so that the flange is in level with the alveolar crest in an edentulous site, or 2–3 mm subcrestal in an extraction site.

First Stage Surgery

1. After implant insertion the Cover Screw (provided in the Implant Kit) is picked up with the Implant Inserter or the Neo screwdriver.

Note: Does not apply to Implant Inserter NP for Ø3.25 implant.

2. The Cover Screw is tightened down firmly onto the implant at a torque not exceeding 10 Ncm.

3. The surgical site is then closed in the normal manner.

Note: Please refer to the recommendations "Post Operative Care" on page 1:22.

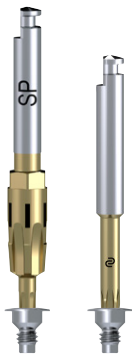

Second Stage Surgery

1. After the healing period a surgical procedure is performed to expose the implants. The Cover Screw is removed with the Neo screwdriver in conjunction with the Manual Handle.
A healing abutment or provisional abutment, including Esthetic Tissue Former, may be placed as per the instructions as outlined in the Single Stage Procedure of this handbook.

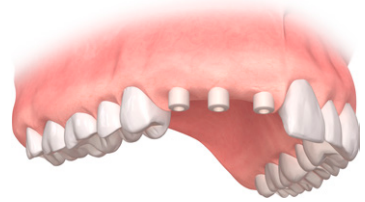

1.5 Post Operative Care

One week following the operation the patient is recalled for routine post operative checks. The sutures are removed at this time and the surgical site is checked for complete soft-tissue healing over the implants or around the healing abutment for the 1-stage protocol.

If the patient is wearing a removable prosthesis it is relieved from any compression over the implant site, relined and delivered back to the patient.

The healing period for osseointegration varies but is dependent on certain criteria:

- initial stability of implant at time of placement
- bone quality
- grafted bone
- overall patient health
- expected masticatory forces

Generally the principles followed are for the Mandible a minimum of 3 months and in the Maxilla at least 6 months.

Published data however shows excellent long term success with immediate loaded implants, and implants loaded at approximately 6–8 weeks. The decision as to when to load any implants should be assessed at the time of surgical placement and based on the known criteria.

The Neoss System implants may be loaded at any time – immediately, 6–8 weeks or after such time as the surgical clinician deems appropriate based on their experience and the above mentioned criteria. The patient is reviewed during the healing phase.

Disclaimer of Liability

Neoss products may only be used according to the manufacturers' instructions and recommendations.

The user of Neoss products should determine their suitability for particular patients and indications.

Neoss Limited disclaims any liability, expressed or implied, and shall have no responsibility for any direct, indirect, punitive or other damages arising out of or in connection with any errors in professional judgement or practice in the use or placement of the Neoss products.

Product images are not to scale and are subject to change.

Copyrights, design rights and trademarks:

Neoss documents, software and designs may not be reprinted, copied or published in whole or part, without the written authorization of Neoss Limited. Neoss, 'N' logo, NeoLink, NeoLoc and Neoss ProActive are registered trademarks of Neoss Limited.

Caution:

Federal (USA) law restricts this device to sale by or on the order of a licensed dentist or physician.



Neoss AB

Arvid Wallgrens backe 20
413 46 Göteborg
Sweden
T +46 (0)31 88 12 80
W www.neoss.com



The Neoss implant assortment has FDA clearance for immediate placement and function recognizing sufficient bone stability and appropriate occlusal loading to restore chewing function.